

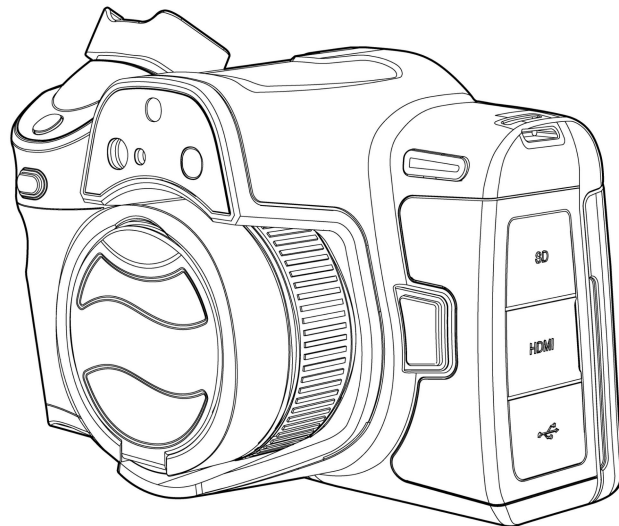

# RS Series

## Flagship Thermal Camera

### User Manual V1.0.0



RayThink Technology Co., Ltd

## Table of Contents

<b>1. Safety Information</b> .....	<b>1</b>
<b>2. Introduction</b> .....	<b>5</b>
2.1. General description .....	5
2.2. Key benefits .....	5
2.3. Packaging List .....	6
<b>3. Camera Overview</b> .....	<b>7</b>
3.1. View from the left .....	7
3.2. View form the right .....	8
3.3. View from the front .....	9
3.4. View from the bottom .....	10
<b>4. Quick Start Guide</b> .....	<b>11</b>
<b>5. Screen Elements</b> .....	<b>12</b>
5.1. Explanation .....	12
5.2. Status Indicators .....	13
5.3. Additional Image Information .....	13
<b>6. Shortcut Tool Bar</b> .....	<b>14</b>
6.1. Navigating the menu system .....	15
6.2. Navigating using the joystick .....	15
<b>7. Handling the camera</b> .....	<b>16</b>
7.1. Charging the battery .....	16
7.1.1. Charge with power adapter .....	16
7.1.2. Charge via PC .....	16
7.1.3. Using the stand-alone battery charger to charge the battery .....	16
7.2. Turning on and turning off the camera .....	17
7.3. Viewfinder .....	17
7.3.1. Viewfinder Switch .....	17
7.3.2. Adjusting the viewfinder's dioptic correction .....	17
7.4. Adjusting the angle of the lens .....	18
7.5. Laser Range Finding .....	18
7.6. Adjusting the infrared camera focus .....	19
7.7. One-click Center Focus .....	20
7.8. Auto Center Focus .....	20
7.9. Using the digital zoom function .....	21
7.10. Assigning functions to the programmable buttons .....	21
7.11. Changing lenses .....	22

7.12. Survey Analysis .....	24
<b>8. Saving and working with images .....</b>	<b>25</b>
8.1. About image files .....	25
8.2. File-naming convention .....	25
8.3. Storage capacity .....	25
8.4. Saving an image .....	25
8.5. Previewing an image .....	25
8.6. Opening a saved image .....	26
8.7. Displaying image information .....	26
8.8. Renaming an image .....	27
8.9. Editing a Saved Image .....	27
8.10. Create PDF Reports .....	28
8.11. Delete Image .....	28
8.12. Delete Multiple Images .....	29
8.13. Delete Multiple Files .....	29
8.14. Reset Image Counter .....	29
8.15. Image Annotations .....	30
8.15.1. Add Text Annotations .....	30
8.15.2. Add Voice Annotations .....	32
8.15.3. Add Sketch .....	33
<b>9. Recording Settings .....</b>	<b>34</b>
9.1. Video Recording .....	34
9.2. Video Processing .....	35
<b>10. Image Effect Adjustment .....</b>	<b>36</b>
10.1. Thermal Camera Focusing .....	36
10.2. LEVEL and SPAN Adjustment .....	37
10.3. Temperature Measurement Range .....	38
10.4. Changing the color palette .....	39
10.5. Changing the environmental parameters .....	43
10.6. Image Calibration .....	43
10.7. Set Image Mode .....	43
<b>11. Analysis Setting .....</b>	<b>45</b>
11.1. Add/Delete Analysis Tools .....	46
11.2. User Preset Settings .....	47
11.3. Move or Adjust Analysis Tools .....	48
11.4. Changing Parameters of Analysis Tool .....	50
11.4.1. Parameter Type .....	50

11.4.2. Recommended Values .....	51
11.4.3. Change Parameters .....	51
11.5. Change Properties of Analysis Tool .....	53
11.6. Set Analysis Tool Alarm .....	53
11.6.1. Alarm Type .....	53
11.6.2. Alarm Signal .....	54
11.6.3. Alarm Settings .....	54
11.7. Isotherm .....	55
<b>12. Remote Connection and Control .....</b>	<b>56</b>
<b>13. Cloud Platform .....</b>	<b>57</b>
<b>14. Wireless Projection .....</b>	<b>57</b>
<b>15. FTP .....</b>	<b>58</b>
<b>16. Data Sharing .....</b>	<b>60</b>
<b>17. Settings .....</b>	<b>60</b>
17.1. Function Settings .....	60
17.1.1. Default Text .....	61
17.1.2. Filename Prefixes .....	62
17.1.3. Edit Report Templates .....	62
17.2. Environmental Parameters .....	62
17.3. Analysis Settings .....	62
17.4. Alarm Settings .....	63
17.5. Time-lapse Image Capture .....	63
17.6. System Settings .....	64
17.6.1. Wi-Fi Settings .....	65
17.6.2. Configure Mobile Data .....	66
17.6.3. Bluetooth Pairing .....	66
17.6.4. Language and Date .....	67
17.6.5. Auto Screen Timeout .....	68
17.6.6. Brightness .....	69
17.6.7. Volume .....	69
17.6.8. GPS .....	69
17.6.9. Virtual Buttons .....	69
17.6.10. Storage Settings .....	70
17.6.11. External SD Card .....	70
17.6.12. Alignment Parameter Reset .....	71
17.6.13. Reset Parameters .....	71
17.6.14. Factory Reset .....	71



## RS Series Flagship Thermal Camera User Manual

---

17.6.15. Software Update .....	71
17.7. Smart Capture .....	72
17.8. Smart Diagnostics .....	75
<b>18. Technical Data .....</b>	<b>77</b>
18.1. RS1280 25° .....	77
18.2. RS600 25° .....	80
<b>19. Applications Introduction .....</b>	<b>83</b>
19.1. Smart Power Inspection and Diagnosis .....	83
19.2. Storage Level Detection .....	84
19.3. PCB Inspection .....	85
19.4. Rotary Kiln Defect Monitoring .....	85
<b>20. Dimensions .....</b>	<b>86</b>
<b>21. Cleaning Thermal Camera .....</b>	<b>86</b>
21.1. Cleaning Camera Housing, Cables and Other Items .....	86
21.2. Cleaning Infrared Lens .....	87
21.3. Clean Infrared Detector .....	87
<b>Appendix A Emissivity of Common Materials .....</b>	<b>88</b>

## 1. Safety Information



### WARNING

Any Changes or modifications not expressly approved by the party responsible for compliance could void the user's authority to operate the equipment.

The device has been evaluated to meet general RF exposure requirement. The device can be used in portable exposure condition without restriction.

This device was tested for typical body-worn operations. To comply with RF exposure requirements, a minimum separation distance of 0.5 cm must be maintained between the user's body and the handset, including the antenna. Third-party belt-clips, holsters, and similar accessories used by this device should not contain any metallic components. Body-worn accessories that do not meet these requirements may not comply with RF exposure requirements and should be avoided. Use only the supplied or an approved antenna.

Applicability: Cameras with one or more laser pointers.

Do not look directly into the laser beam. The laser beam can cause eye irritation.

Applicability: Cameras with one or more batteries.

Do not disassemble or do a modification to the battery. The battery contains safety and protection devices which, if damage occurs, can cause the battery to become hot, or cause an explosion or an ignition.

Applicability: Cameras with one or more batteries.

If there is a leak from the battery and you get the fluid in your eyes, do not rub your eyes. Flush well with water and immediately get medical care. The battery fluid can cause injury to your eyes if you do not do this.

Applicability: Cameras with one or more batteries.

Do not continue to charge the battery if it does not become charged in the specified charging time. If you continue to charge the battery, it can become hot and cause an explosion or ignition. Injury to persons can occur.

Applicability: Cameras with one or more batteries.

Only use the correct equipment to remove the electrical power from the battery. If you do not use the correct equipment, you can decrease the performance or the life cycle of the battery. If you do not use the correct equipment, an incorrect flow of current to the battery can occur. This can cause the battery to become hot, or cause an explosion. Injury to persons can occur.

## RS Series Flagship Thermal Camera User Manual

Make sure that you read all applicable MSDS (Material Safety Data Sheets) and warning labels on containers before you use a liquid. The liquids can be dangerous. Injury to persons can occur.

Make sure you read all applicable Material Safety Data Sheets (SDS) and warning labels on containers before you use a liquid. The liquids can be dangerous. Injury to persons can occur.

Do not place the product in high-temperature environments above 85 ° C or low-temperature environments below -45°C.

Unauthorized disassembly or modification of the infrared thermal camera is prohibited.



### CAUTION

1. Do not use the product under conditions that doesn't match the environmental requirements. For specific use environment requirements, see the product parameter table.

2. Do not apply solvents or equivalent liquids to the camera, the cables, or other items.

3. Be careful when you clean the infrared lenses. The lens has an anti-reflective coating which is easily damaged. Damage to the infrared lens can occur with too much force or cleaning with rough objects such as tissues.

4. No matter there is a lens cover or not, do not point the infrared thermal camera towards strong light or equipment with laser radiation. This will affect the accuracy of the thermal camera and even damage the detector in the thermal camera.

Do not use the camera in temperatures more than +50°C, unless other information is specified in the user documentation or technical data. High temperatures can cause damage to the camera.

Do not point the infrared camera (with or without the lens cover) at strong energy sources, for example, devices that cause laser radiation, or the sun. This can have an unwanted effect on the accuracy of the camera. It can also cause damage to the detector in the camera.

Applicability: Cameras with one or more laser pointers.

To prevent damage, put the protective cap on the laser pointer when you do not operate the laser pointer. Damage to the laser pointer can occur if you do not do this.

Applicability: Cameras with one or more batteries.

Do not attach the batteries directly to a car's cigarette lighter socket, unless a specific adapter is provided to connect the batteries to a cigarette lighter socket. Damage to the batteries can occur.

Applicability: Cameras with one or more batteries.

Do not connect the positive terminal and the negative terminal of the battery to each other with a metal object (such as wire). Damage to the batteries can occur.

Applicability: Cameras with one or more batteries.

Do not get water or salt water on the battery, or permit the battery to become wet. Damage to the batteries can occur.

Applicability: Cameras with one or more batteries.

Do not make holes in the battery with objects. Damage to the battery can occur.

Applicability: Cameras with one or more batteries.

Do not hit the battery with a hammer. Damage to the battery can occur.

Applicability: Cameras with one or more batteries.

Do not put your foot on the battery, hit it or cause shocks to it. Damage to the battery can occur.

Applicability: Cameras with one or more batteries.

Do not put the batteries in or near a fire, or into direct sunlight. When the battery becomes hot, the built-in safety equipment becomes energized and can stop the battery charging procedure. If the battery becomes hot, damage can occur to the safety equipment and this can cause more heat, damage or ignition of the battery.

Applicability: Cameras with one or more batteries.

Do not put the battery on a fire or increase the temperature of the battery with heat. Damage to the battery and injury to persons can occur.

Applicability: Cameras with one or more batteries.

Do not put the battery on or near fires, stoves, or other high-temperature locations. Damage to the battery and injury to persons can occur.

Applicability: Cameras with one or more batteries.

Do not solder directly onto the battery. Damage to the battery can occur.

Applicability: Cameras with one or more batteries.

Do not use the battery if, when you use, charge, or put the battery in storage, there is an unusual smell from the battery, the battery feels hot, changes color, changes shape, or is in an unusual condition. Speak with your sales office if one or more of these problems occurs. Damage to the battery and injury to persons can occur.

Applicability: Cameras with one or more batteries.

Only use a specified battery charger when you charge the battery. Damage to the battery can occur if you do not do this.

Applicability: Cameras with one or more batteries.

Only use a specified battery for the camera. Damage to the camera and the battery can occur if you do not do this.

Applicability: Cameras with one or more batteries.

The temperature range through which you can charge the battery is  $\pm 0^{\circ}\text{C}$  to  $+45^{\circ}\text{C}$  ( $+32^{\circ}\text{F}$  to  $+113^{\circ}\text{F}$ ), unless other information is specified in the user documentation or technical data. If you charge the battery at temperatures out of this range, it can cause the battery to become hot or to break. It can also decrease the performance or the life cycle of the battery.

Applicability: Cameras with one or more batteries.

The temperature range through which you can remove the electrical power from the battery is  $-20^{\circ}\text{C}$  to  $+60^{\circ}\text{C}$ , unless other information is specified in the user documentation or technical data. If you operate the battery out of this temperature range, it can decrease the performance or the life cycle of the battery.

Applicability: Cameras with one or more batteries.

When the battery is worn, apply insulation to the terminals with adhesive tape or equivalent materials before you discard it. Damage to the battery and injury to persons can occur if you do not do this.

Applicability: Cameras with one or more batteries.

Remove any water or moisture on the battery before you install it. Damage to the battery can occur if you do not do this.

Do not apply solvents or equivalent liquids to the camera, the cables, or other items. Damage to the battery and injury to persons can occur.

Be careful when you clean the infrared lens. The lens has an anti-reflective coating which is easily damaged. Damage to the infrared lens can occur.

Do not use too much force to clean the infrared lens. This can cause damage to the anti-reflective coating.



2006/66/EC (battery directive): This product contains a battery that cannot be disposed of as unsorted municipal waste in the European Union. See the product documentation for specific battery information. The battery is marked with this symbol, which may include lettering to indicate cadmium (Cd), lead (Pb), or mercury (Hg). For proper recycling, return the battery to your supplier or to a designated collection point. For more information see: [www.recyclethis.info](http://www.recyclethis.info)



2012/19/EU (WEEE directive): Products marked with this symbol cannot be disposed of as unsorted municipal waste in the European Union. For proper recycling, return this product to your local supplier upon the purchase of equivalent new equipment, or dispose of it at designated collection points. For more information see: [www.recyclethis.info](http://www.recyclethis.info)

## 2. Introduction

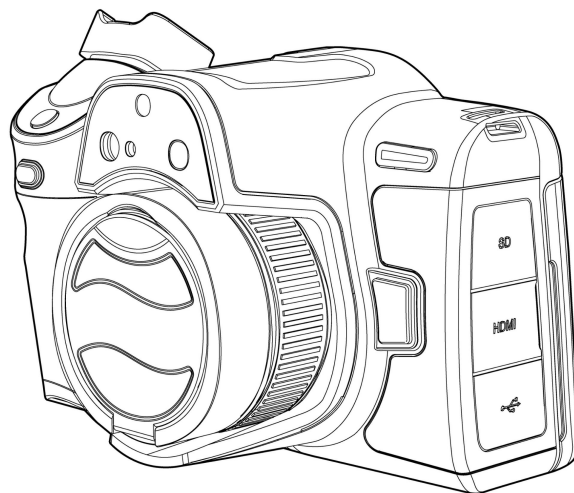

### 2.1. General description

The camera is designed for the expert requiring the highest performance and the latest technology available. The camera series have excellent ergonomics, and can achieve high accuracy and high-quality image with high-sensitivity and high-resolution infrared detectors. Custom OS, intelligent application and assisted function, 5.5-inch angle adjustable screen and rotatable handles make it well suited for professional use.

### 2.2. Key benefits











- Tailor made for research and development: The camera has high accuracy and high sensitivity, to

## RS Series Flagship Thermal Camera·User Manual

accurately measure the smallest temperature differences. With real-time radiometric recording by the camera, it is possible to capture fast events on the camera's SD card for further analysis by the supplied analysis software.

- Flexible and feature rich: A wide variety of measuring and analysis functions makes the camera flexible for your every need. The programmable buttons and AI function improves the interaction and control ability.
- Highest performance with the latest technology: The camera is equipped with the innovative intelligent image fusion feature, which produces an image richer in detail than ever before. With its continuous autofocus, the image continues to be clear, which improves work efficiency greatly.
- Intelligent Work Flow: The camera is integrated with Work Flow Template, which can be edited via software, auto image naming and complete complicated work flow with multiple image annotation and memory function.

### 2.3.Packaging List

Standard Accessories				
				
Thermal camera	Li-ion battery	Power adapter	USB cable	HDMI cable
				
Neck strap	Hand strap	SD card	Hard safety case	Battery charger
Docking charger cable	Download card	Calibration certificate	Quick start guide	User documentation

Optional Accessories				
Li-ion battery	Bluetooth headsets	Long focus lens	Wide angle lens	Micro-lens
Lens bag	Portable bag			

### 3. Camera Overview

#### 3.1.View from the left

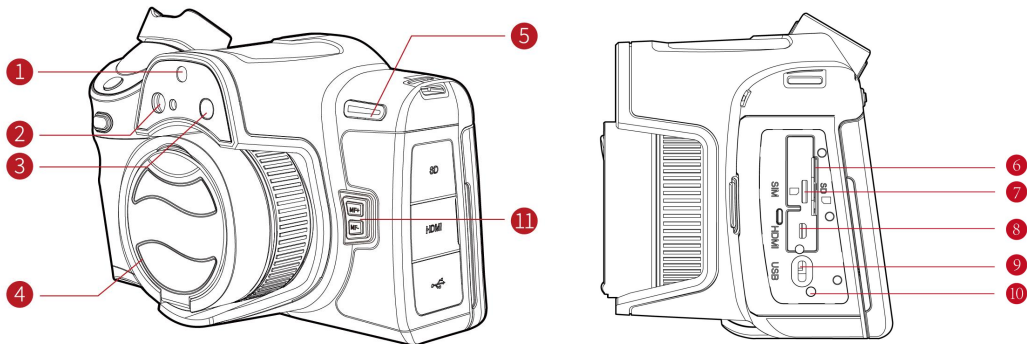

No.	Name	Function Description
1	Visible light	
2	LRF	
3	LED supplement light	
4	Infrared lens	
5	Power button	Press and hold for 3s to power on; Press and hold for 3s to display power off/reboot menu; Press to enter sleep mode.
6	SD card slot	Standard 64GB, support hot plug, support SD, SDHC, SDXC, Max. extendable to 2TB; Remove SD card and transmit data to PC or other devices via card reader. <b>Note:</b> Damage to memory card may occur if the memory card is removed when SD card is operating.
7	SIM card slot	Mobile network <b>Note:</b> only applicable to some models



## RS Series Flagship Thermal Camera·User Manual

8	Micro HDMI output port	digital video output
9	USB port	charge or data transmission
10	Charge indicator	Power, charging and connection status indicator; The red LED glows continuously: the battery is being charged; The green LED glows continuously: the battery is fully charged.
11	Manual focus button	Manual focus adjustment, only for RS600/RS400 series

### 3.2.View form the right

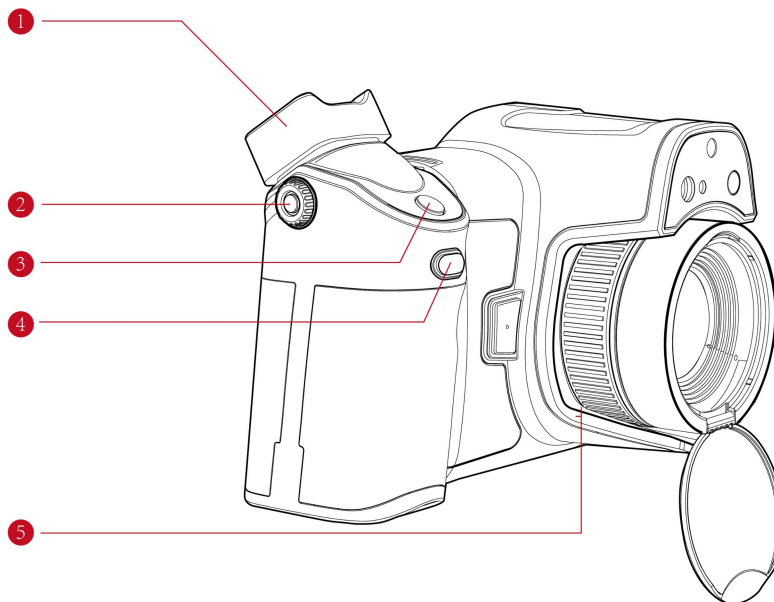

No.	Name	Function Descriptions
1	Viewfinder	
2	Viewfinder Diopter Knob	Change the diopter of the viewfinder.
3	Image Capture Button	Press: image capture; Press and hold: start/end video capture
4	Auto Focus Button	Short press for one-click center focus; long press to enable/disable auto center focus
5	Manual Focus Ring	Adjust the focus manually, for RS1280 series only

### 3.3. View from the front

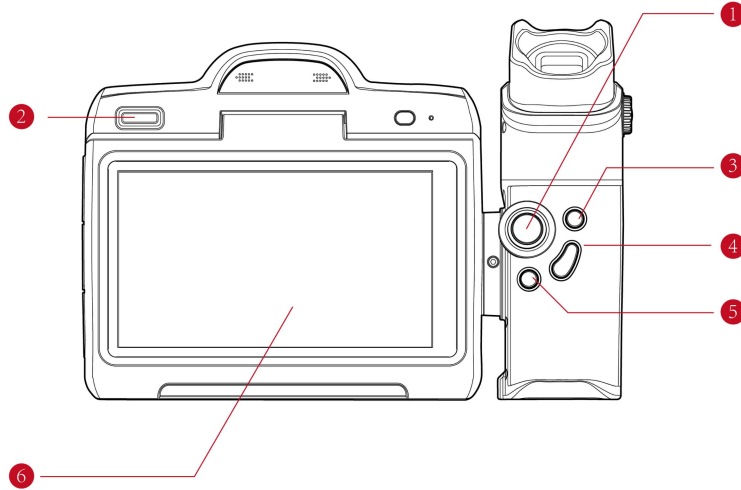



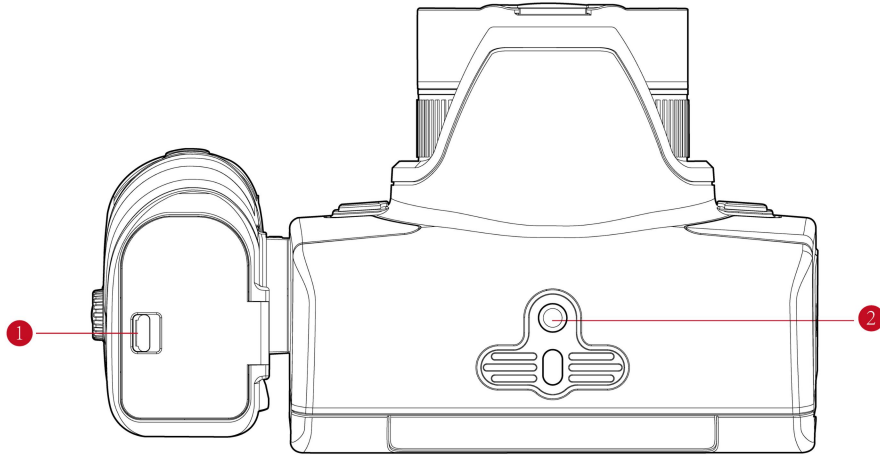

No.	Name	Function Description
1	Joystick Button	Menu navigation; Select and change value
2	LCD/Viewfinder toggle button	Press: toggle between LCD screen and viewfinder
3	Playback Button	Press: open gallery; Press and hold for 2S to perform manual correction
4	OK/Programmable Button	OK button: click Programmable button: press and hold, including voice recognition, laser range finding <b>Note:</b> only available for some models
5	Back Button	Dialogue box and menu
6	LCD touch screen	

### 3.4. View from the bottom



No.	Name	Function Description
1	Battery Compartment	Detachable battery
2	Tripod Mount Interface	Support standard 1/4"-20-UNC

## 4. Quick Start Guide

<p><b>Please follow the below steps.</b></p>
<p><b>Memory:</b> open the silicone cap on the left, inserted the dedicated SD card in the accessories, then seal the silicone cap.</p>
<p><b>Battery:</b> open the battery compartment cap on the handle bottom, insert the dedicated battery in the accessory and close the cap of the battery compartment.</p>
<p><b>Power Supply:</b> Power on by pressing and holding the ON button for 3 sec; press and hold OFF button for 3 seconds to pop up off/reboot menu; Press to enter sleep mode.</p>
<p><b>Focus</b></p> <ul style="list-style-type: none"> <li>● Manual focus, rotate the lens focus ring.</li> <li>● Auto focus, press the Auto Focus button.</li> <li>● Laser-aided focus, go to  (Settings) &gt;Function &gt;Focus Mode=Laser aided focus via joystick button.</li> </ul>
<p><b>Image Capture</b></p> <ul style="list-style-type: none"> <li>● Image Freeze, go to  (Settings)&gt;Function&gt;Image Analysis=ON via joystick button, the image is frozen and enter into image preview interface after pressing the image capture button.</li> <li>● Pressing the image capture button is OK if the image analysis is disabled.</li> </ul>
<p><b>Image Replay</b></p> <ul style="list-style-type: none"> <li>● Click Gallery button.</li> <li>● Push the joystick button, select the file via up/down/left/right button.</li> <li>● Press Ok button to enter image preview interface.</li> </ul>
<p><b>Color Palettes</b></p> <ul style="list-style-type: none"> <li>● Go to  (Color Palettes) via joystick button.</li> <li>● Enter to submenu by pressing OK button.</li> <li>● Select a different color palette via joystick button.</li> <li>● Confirm by pressing Ok button.</li> </ul>
<p><b>Temperature Measurement Range</b></p> <p>Go to  (Settings) &gt;Function&gt;Measurement Range=No via joystick button, select the appropriate temperature measurement range and press Ok button.</p>

**PC Software Analysis**

- Download the client software, then start the software.
- Export the data to perform secondary analysis via USB cable or SD card.
- The thermal camera is connected via WLAN or hotspot, and ensure that the PC and the thermal camera is in the same LAN, then perform secondary analysis.

**APP Analysis**

Download mobile App, start the application software, The thermal camera is connected via WLAN or hotspot, the mobile device can find and connect with the thermal camera to perform secondary analysis via search function.

**5. Screen Elements**

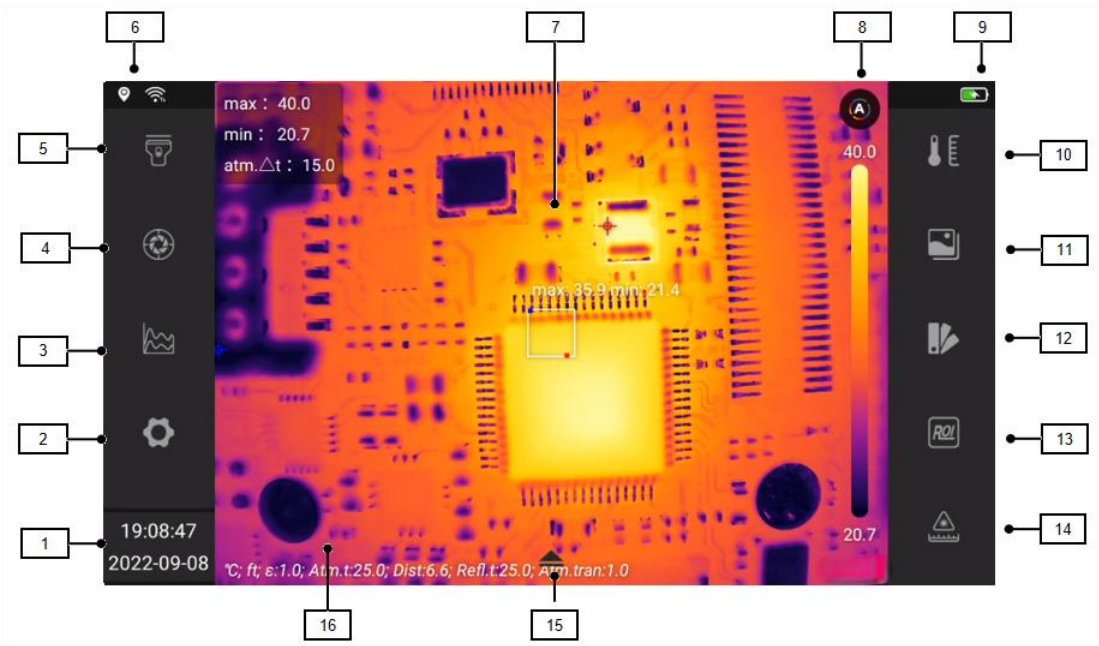









**5.1.Explanation**

No.	Name	Description
1	Date & Time	Present Date and Time
2	Setting Button	Press to enter settings interface
3	Isotherm Button	Press to open isotherm sub menu
4	Image Calibration Button	Press to perform manual calibration
5	Flashlight	Press to turn on LED lamp

6	Status Indicator	Present current connection status of Wi-Fi, Bluetooth
7	Image Display Area	Display current real-time image and OSD (Environmental parameters, analyzing tools)
8	Temperature Scale	Mode switch button, measuring scale
9	Status Indicator	Present current location, power capacity info
10	Buttons	Press to present analyzing parameter settings: emissivity, atmospheric temperature, distance, atmospheric transmissivity, reflected temperature
11	Image Mode Button	Press to enter image mode submenu
12	Color Palettes Button	Press to enter submenu
13	Analyzing Button	Press to enter submenu, select spot/ line/ box/circle/polygon
14	LRF Button	Press to enable laser range finding function and present target distance
15	Extended Tool Bar Button	Wake extended tool bar
16	Extended Tool Bar	Including image/video capture, gallery, manual focus, zoom in/out

## 5.2. Status Indicators

	<p><b>Battery level indicators</b></p> <p>: slow charging indicator</p> <p>: fast charging indicator</p>
	<p><b>GPS status indicator</b></p> <p>Grey: GPS disabled</p> <p>White: GPS enabled</p>
	<p><b>Bluetooth status indicator</b></p> <p>Grey: Bluetooth enabled, no pairing device</p> <p>White: Bluetooth enabled, device paired</p>
	<p><b>Wi-Fi connection status indicator</b></p> <p>: Wi-Fi enabled, disconnected</p> <p>: Wi-Fi enabled, connected</p>

## 5.3. Additional Image Information

Additional image information includes emissivity, atmospheric temperature, target distance and location, which are stored in the image files and can be viewed in the gallery. The additional information can be presented on the real-time image via configurations and OSD overlaid on the saved image.

## 6. Shortcut Tool Bar



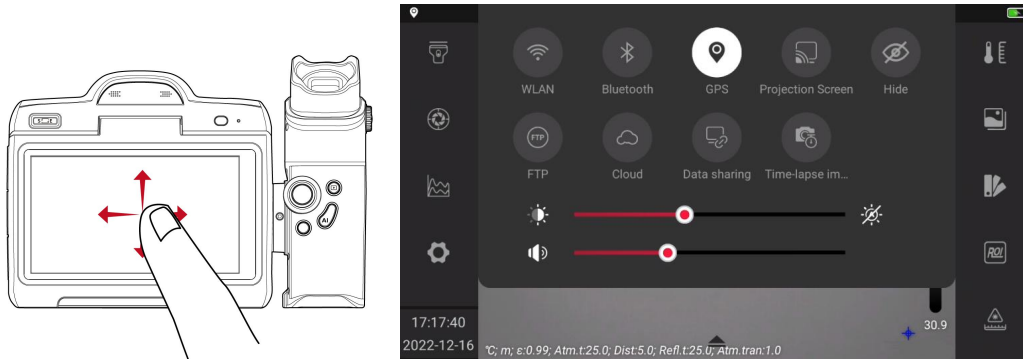

To open the swipe-down menu, place your finger at the top of the screen and swipe down.



To perform fast configuration via shortcut tool bar, including: (WLAN), (Bluetooth), (GPS), (Projection Screen), (FTP), (Cloud), (Data sharing), (time-lapsed image capture), (hide).

1. Select to configure Wi-Fi, short press to enable/disable, long press to enter detailed setting interface, please refer to 17.6.1 for detailed information.
2. Select to configure Mobile Data, short press to enable/disable, long press to enter the detailed settings interface. Please refer to section 17.6.2 for configuring mobile data.
3. Select to configure Bluetooth, short press to enable/disable, long press to enter detailed setting interface, please refer to 17.6.3 for detailed information on Bluetooth pairing.
4. Select to configure GPS, short press to enable/disable, please refer to 17.6.8 for detailed information on GPS.
5. Select to configure wireless projection screen, short press to enable/disable, please refer to chapter 14 for detailed information on wireless projection screen.
6. Select to configure FTP service, please refer to chapter 15 for detailed information on FTP.
7. Select to configure cloud service, short press to enable/disable, please refer to chapter 13 for detailed information on cloud.
8. Select to configure data sharing service, short press to enable/disable, please refer to chapter

16 for detailed information on data sharing.

9. Select  configure time-lapsed image capture service, short press to enable/disable, please refer to chapter 17.5 for detailed information on time-lapsed image capture.
10. Click  Hide Services to instantly hide screen overlay information.
11. Move  slider to set screen brightness, press  to enable/disable auto screen brightness.
12. Move  slider to set volume.

### 6.1. Navigating the menu system

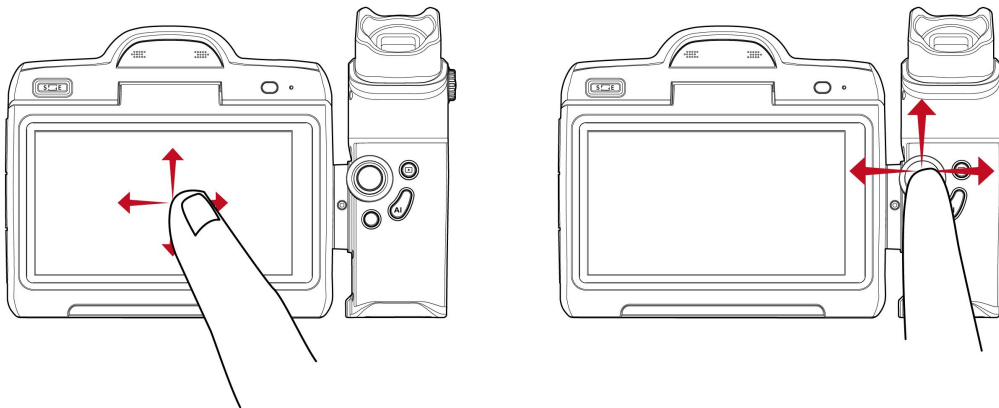

The above figures illustrate two ways of navigating menu systems:

- Using your finger or a stylus pen specially designed for capacitive touch usage. (Figure on the left)
- Using the joystick and the back button. Or two types as a combination.

We suppose to navigate with joystick in this manual, but you can also navigate with finger or a stylus pen in most cases.

### 6.2. Navigating using the joystick

Navigate the menu system by using the joystick and the back button:

1. To navigate in menus, submenus, and dialog boxes, and to change values in dialog boxes, move the joystick up/down or left/right.
2. To confirm changes and settings in menus and dialog boxes, Press Ok button or Programmable button.
3. To leave dialog boxes and to go back in the menu system, push the back button  .



## 7. Handling the camera

### 7.1.Charging the battery

**Note:**

- You must charge the battery for 4 hours before you start using the camera for the first time. Ensure fast charging with the charger delivered with the product.
- The adapter can charge the charging base and the camera, please choose the correct USB cable, The cradle charging cable is used with the charging dock, while the USB charging cable is used with the device..

#### 7.1.1. Charge with power adapter

**Please follow the below steps:**

1. Connect the black USB cable plug to the Type-C connector on the thermal camera.
2. Connect the black USB cable with the power adapter and plug to a mains socket.
3. The green LED glows continuously: the battery is fully charged, then disconnect USB cable.

#### 7.1.2. Charge via PC

Charge by connecting the thermal camera to the PC with black USB cable.

**Note:** The computer should be turned on when charging via computer, which costs more time than charging with power adapter.

#### 7.1.3. Using the stand-alone battery charger to charge the battery

Stand-alone battery charger LED indicator:

Type of signal	Explanation
The green LED glows continuously.	No battery or the battery is fully charged.
The red LED glows continuously.	The battery is being charged.

**Please follow the below steps:**

1. Use the docking charger cable to connect the power adapter and the charging dock, then plug the power adapter into the socket.
2. Put the battery in the battery charger.

**Note:** if you charge the battery via charging base, the matched charging cable should be used to enter fast charge status.

### 7.2. Turning on and turning off the camera

1. To turn on the camera, press and hold the On/off button for 3s.
2. To turn off the camera, push and hold the On/off button for more than 3s, touch the  button.
3. To reboot the camera, push and hold the power button for more than 15s.

**Note:** Do not remove the battery to turn off the camera.

### 7.3. Viewfinder



#### CAUTION

Make sure that the beams from the intensive energy sources do not go into the viewfinder. The beams can cause damage to the camera. This includes the devices that emit laser radiation, or the sun.

#### 7.3.1. Viewfinder Switch

LCD touch screen display by default after power on, press LCD/Viewfinder button to switch, LCD will be off, the viewfinder is on. Press LCD/Viewfinder button again, the LCD will screen is displayed, the viewfinder will be off.

#### 7.3.2. Adjusting the viewfinder's dioptic correction

You can make the image sharper by adjusting the viewfinder's dioptic correction. To adjust the viewfinder's dioptic correction, look through the viewfinder and rotate the adjustment knob clockwise or counter-clockwise for the best sharpness.

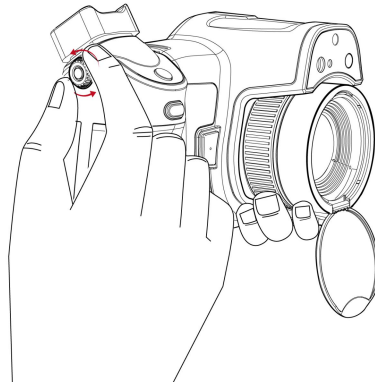

#### 7.4.Adjusting the angle of the lens

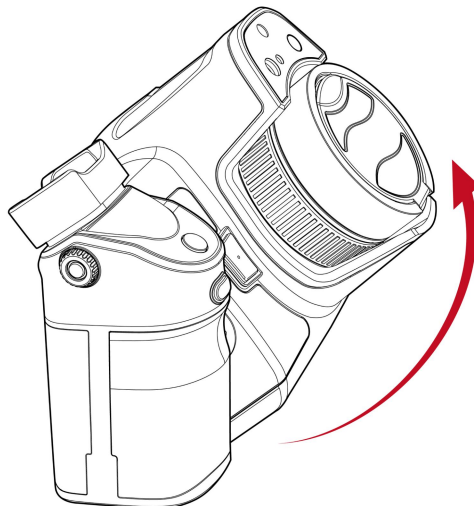

#### 7.5.Laser Range Finding



#### **WARNING**

Do not look directly into the laser beam. The laser beam can cause eye irritation.

**Please follow the below steps:**

1. Go to  (LRF) via joystick button.
2. Press Ok button to turn on laser range finding to perform continuous range finding, the measured

value is displayed on the top left of the screen.

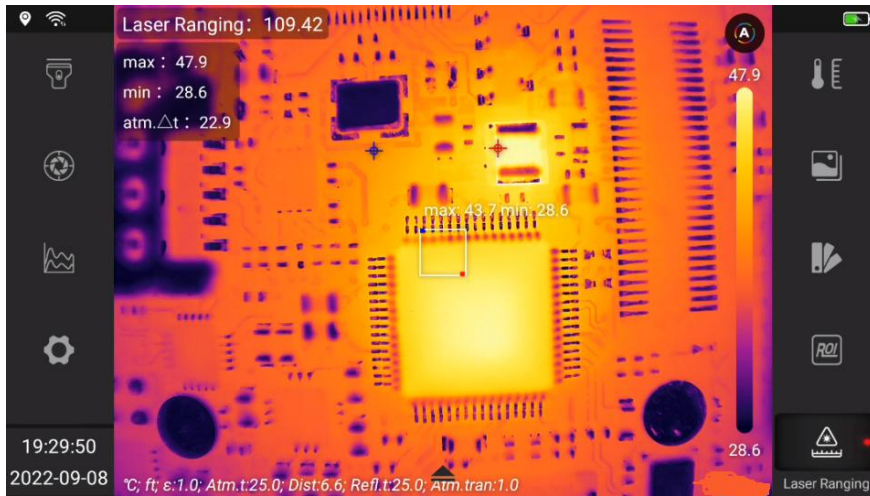

### 7.6. Adjusting the infrared camera focus

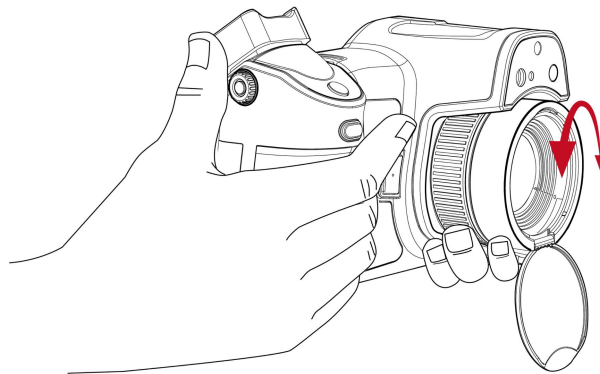

#### Please follow this procedure:

Execute one of the following operations:

- For far focus, rotate the focus ring clockwise.
- For near focus, rotate the focus ring anticlockwise.

#### Note:

- Do not touch the lens surface when you adjust the infrared camera focus manually. If this happens, clean the lens according to the instructions in 21.2 Cleaning Infrared lens.
- The focus ring can be rotated infinitely, but only a certain amount of rotation is needed when focusing.

- *The response of the focus mechanism is progressive, meaning that a faster rotation of the focus ring gives a disproportional higher speed of focus change. This allows for both fine adjustment with a relatively large (but slow) rotation and rapid change with a smaller (but faster) rotation. Furthermore, for a very slow rotation, the lens moves in very small, discrete steps (which you can hear), allowing for a controlled fine adjustment of the focus.*

### 7.7. One-click Center Focus

When focusing is needed, you can press the one-click center focus button.

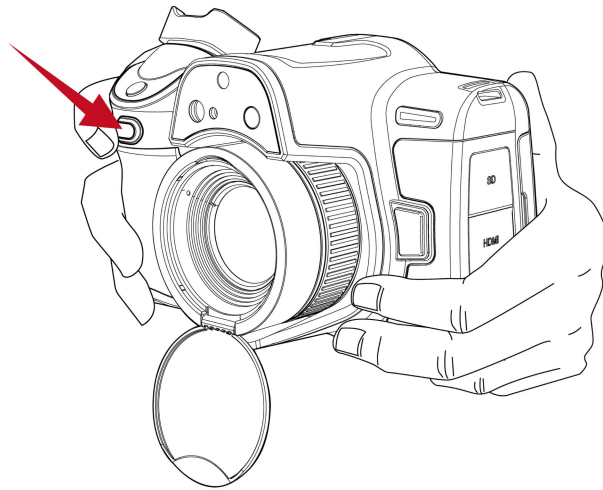

### 7.8. Auto Center Focus

The infrared camera can be configured to auto center focus.

**Note:**

- *When auto center focus is enabled, you can also manually adjust the focus by rotating the focus ring.*
- *To stop auto center focus (e.g., to stabilize the focus before saving an image), Please press and hold the Autofocus button.*

**Follow this procedure:**

To enable auto center focus function, please select  (Settings) >Function Settings>Auto center focus=Yes, you can also press and hold the Autofocus button.



## 7.9. Using the digital zoom function

The current zoom factor is displayed in the upper left corner of the screen.

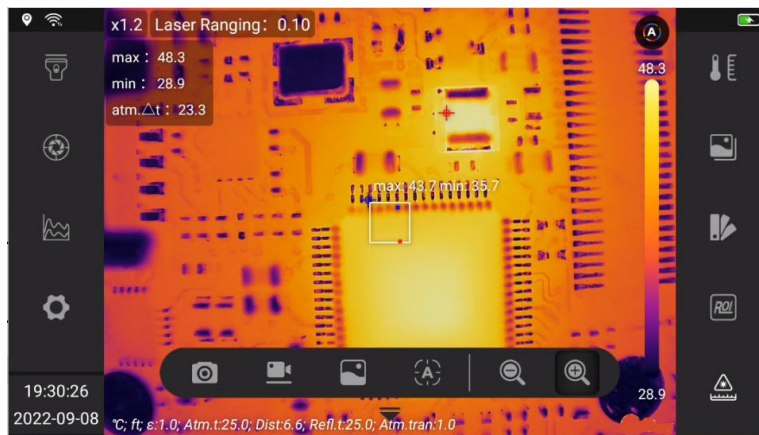
In preview/edit mode, it is possible to pan a zoomed image by touching the screen.



Please follow this procedure:

1. To zoom, click the visual button icon  to wake up visual button tool bar.
2. Click  to zoom in or zoom out.

## 7.10. Assigning functions to the programmable buttons

You can assign different functions to the programmable buttons.

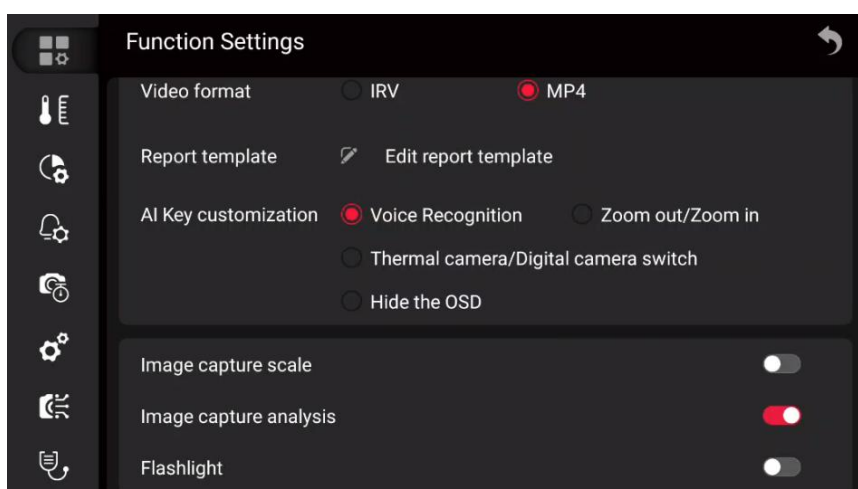

To assign a function to a programmable button, do the following:

1. Go to  (Settings) with joystick and press the OK button.

2. Go to AI Key customization with joystick.
3. Select one of the functions and press the OK button.

### 7.11. Changing lenses

**Note:** Do not touch the lens surface when you change lenses. If this happens, clean the lens according to the instructions in 21.2 Cleaning Infrared lens.

**Follow this procedure:**

1. Take a firm grip around the outermost part of the lens and rotate the lens 90° counter-clockwise.

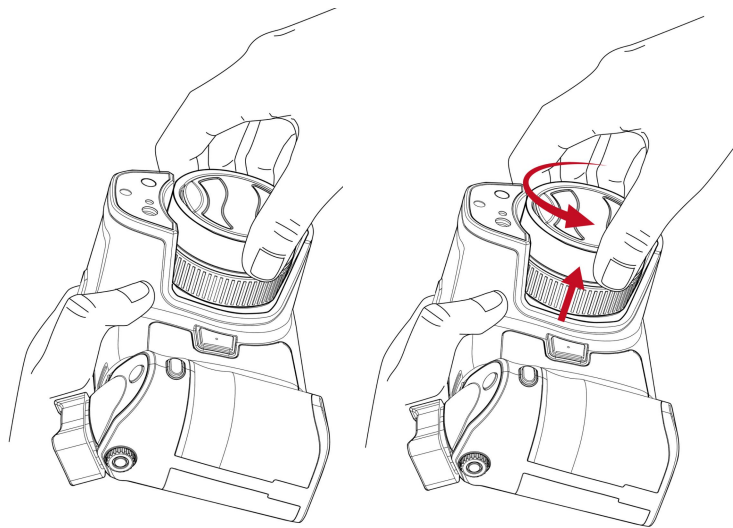

2. Carefully pull out the lens from the lens bayonet mount.

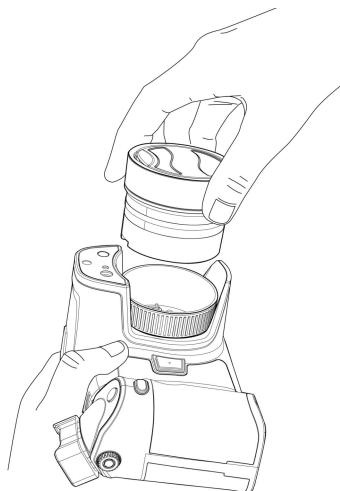

3. The infrared detector is now fully exposed. Do not touch this surface. If you see dust on the detector, follow the instructions in 21.3.

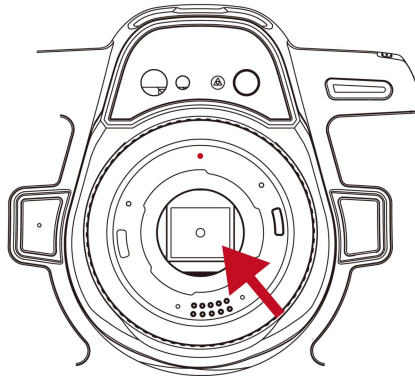

4. Note the index marks on the lens bayonet mount and on the lens.

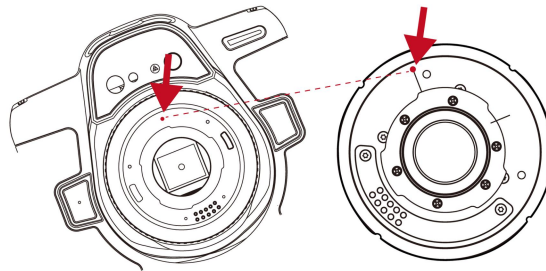

5. Align the lens correctly to the bayonet mount. Carefully push the lens into position.

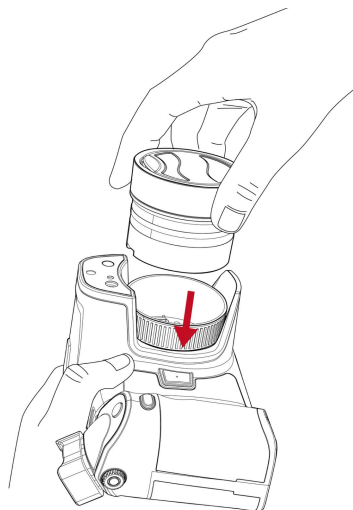

6. Rotate the lens 90° clockwise. The lens makes a click when it locks in place.





## 7.12. Survey Analysis

Distances measured using the laser ranging module can serve as the basis for area calculations. A typical application is estimating the size of damp stains on walls.

Please follow the steps below:

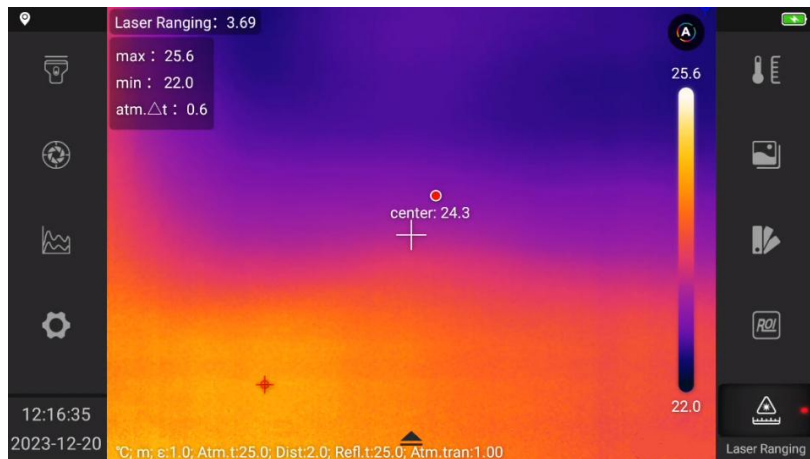
1. Open the laser rangefinder, align the camera with the object to be captured, and capture an image.



2. After entering the gallery, open the image to be analyzed, enter secondary analysis, and click  on the left side to open line or box survey tool.
3. Select the survey tool, draw a box or line along the boundary of the object to be surveyed, displaying the object's dimensions and area.

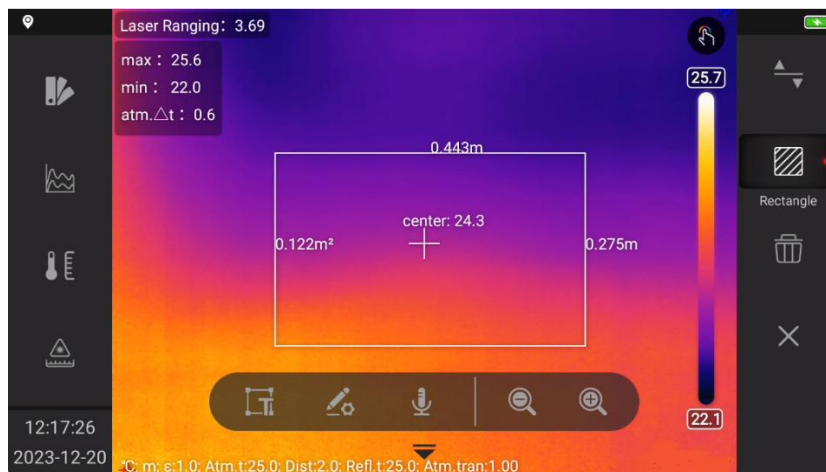

### Notes:

- Ensure that the box or line tool is centered on the image.
- The size of the box or line tool should match the size of the object being surveyed.
- Keep the camera facing the surveyed object.
- Avoid other targets between the laser point and the surveyed object, which may cause ranging errors and affect survey accuracy.

## 8. Saving and working with images

### 8.1. About image files

The image files include thermal information, visual information, environmental parameter and other information, which can be analyzed after being saved, for example, changing image mode, changing color palettes and change/add analyzing tools. The images can be exported to configuring software and being analyzed and generating reports.

### 8.2. File-naming convention

The default naming convention for image files is \*-xxxx-IR.jpg or \*-xxxx-DC.jpg, where \* is user defined prefix added to the file name, xxxx is time stamp, -IR/-DC stands for infrared or visual images, time stamp is a combination of yyyyMMddHHmmss.

### 8.3. Storage capacity

The thermal camera is delivered with a standard 64GB memory card which can save 10000 images theoretically (without voice annotations).

### 8.4. Saving an image

You can save the image into the memory card. To save an image, press and release the image capture button.

### 8.5. Previewing an image

You can preview an image before you save it. This enables you to see if the image contains the information you want before you save it. You can also adjust and edit the image.

**Note** The camera must be configured to display a preview image before saving. Select  (Settings) > Function Settings > Image Capture Analysis = On.

#### Follow this procedure:

1. To preview an image, press and release image capture button. This displays the preview.
2. Manual image adjustment mode is now active and the status icon  is presented. For image







adjustment instructions, see section 10.2 LEVEL and SPAN.

3. For editing instructions, see section 8.9 Editing a saved image.
4. Execute Save or Return.

### 8.6. Opening a saved image

When you save an image, the image file is stored on the memory card. To display the image again, open it from Gallery.

**Follow this procedure:**

1. Push the Gallery button , the image files in the Gallery is arranged according to date by default.
2. To select the image by pushing the joystick up/down or left/right.
3. Select the image you want to view and push the OK button, open the image to enter image preview interface.
4. Do one or more of the following:
  - (1) To view the previous/next image, move the joystick left/right.
  - (2) Select  to read file information, including file name, file size, date, resolution, storage path and capture place.
  - (3) Select  to enter editing interface, refer to section 8.9 to edit a saved image.
  - (4) Select  to upload to cloud, refer to section 13 Cloud.
  - (5) Select  to rename a file.
  - (6) Select  to delete a file.
  - (7) To return to the gallery overview, push  or Back button.

### 8.7. Displaying image information

**Follow this procedure:**

1. Open the image in Gallery.
2. Press the OK button and select from the menu .

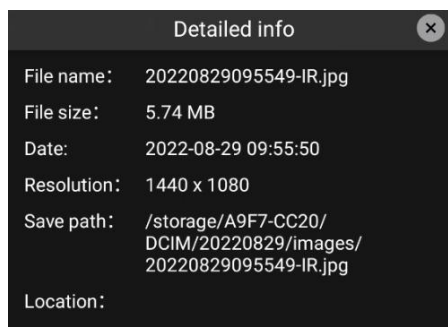

## 8.8. Renaming an image

### Follow this procedure:

1. Open the image in Gallery.
2. Press the OK button and select from the menu , then a dialogue box pops up.

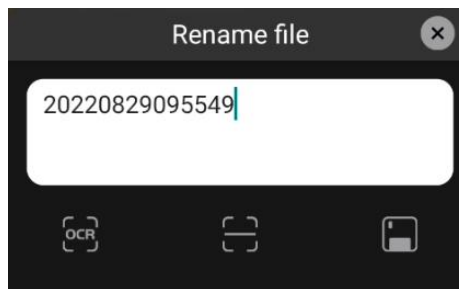











3. You can freely input text, or use OCR to recognize text from photos, or input via QR code scanning.
4. Select  to save.

## 8.9. Editing a Saved Image

You can edit a saved image. You can also edit an image in preview mode.

### Follow this procedure:

1. Open the image in Gallery.
2. Push the Ok button and select  from the menu.
3. The manual image adjustment mode is now active and the status icon  is displayed. For image adjustment instructions, see 10.2 LEVEL and SPAN Adjustment.
4. Perform one or more of the following operations.
  - (1) Select  to save the image as a new image file
  - (2) Select  to discard the modification and exit to the image preview interface.
  - (3) Select  to change image mode, please refer to 10.7 for details.
  - (4) Select  to change palette, please refer to 10.4 for details.
  - (5) Select  to set isotherm, please refer to 11.7 for details.
  - (6) Select  to set environment parameters, please refer to 10.5 for details.
  - (7) Select  to rename the file.

- (8) Select  to add analysis tools, please refer to 11 for details.
- (9) Select  to generate reports, please refer to 8.10 for details.







### 8.10. Create PDF Reports

You can create a PDF report and save it to the memory card. Use configuration software to transfer PDF reports to computers, mobile devices, and send reports to clients.

The naming rule of the report file is REPORT\_XXXX.jpg, where XXXX is the time stamp or reader configured by the system. For the configuration of the suffix, see 8.2 File Naming Rules.

You can edit report templates. For details, see 17.1.3 Editing Report Templates.

#### Please follow these steps.



1. Press the gallery button .
2. Move the joystick up and down or left and right to select the image.
3. Press the OK button to display the image.
4. Select  to enter the image editing interface.
5. Select  to enter the report confirmation interface. Swipe up and down to check whether the content is correct.
6. Perform one or more of the following operations.
  - (1) Select  to return to image editing interface.
  - (2) Select  to save the reports to a memory card.
  - (3) Select  to rename a report.

### 8.11. Delete Image

You can delete a single image file from the memory card.

**Note:** Both images in the image file (thermal image and visual image) will be deleted.



#### Please follow these steps.

1. Press the gallery button .
2. Move the joystick up and down or left and right to select the image to be deleted.
3. Press the OK button to display the image.
4. Press the OK button and select  from the menu. A dialog box will appear.
5. Press the OK button to confirm.

## 8.12. Delete Multiple Images

You can delete multiple images from the memory card.

**Please follow these steps.**



1. Press the gallery button  .
2. Touch and hold one of the images you want to delete and the menu will appear on the right side of the screen.
3. Touch all other images you want to delete, or select all images by selecting .
4. Use the joystick to select  and press the OK button, a dialog box will be displayed for confirmation.
5. Use the joystick to select OK and press OK button to confirm.

## 8.13. Delete Multiple Files

You can delete multiple files from the memory card.

**Note:** This will delete all files (images, videos, and reports) in the folder.

**Please follow these steps.**

1. Press the gallery button  .
2. Touch and hold one of the files you want to delete and the menu will appear on the right side of the screen.
3. Touch all other files you want to delete, or select all images by selecting .
4. Use the joystick to select  and press the OK button, a dialog box will be displayed for confirmation.
5. Use the joystick to select OK and press the OK button to confirm.

## 8.14. Reset Image Counter

You can reset the numbering of image file names.

**Note:** To prevent image files from being overwritten, the new counter value will be based on the highest existing filename number in the gallery.

**Follow these steps.**

1. Press the OK button to display the menu system.
2. Use the joystick to go to Settings.
3. Press the Ok button to display the settings menu.
4. Go to System Settings via the joystick.
5. Go to Reset Options and press OK button.
6. This will display a dialog box, choose Confirm and press the OK button.

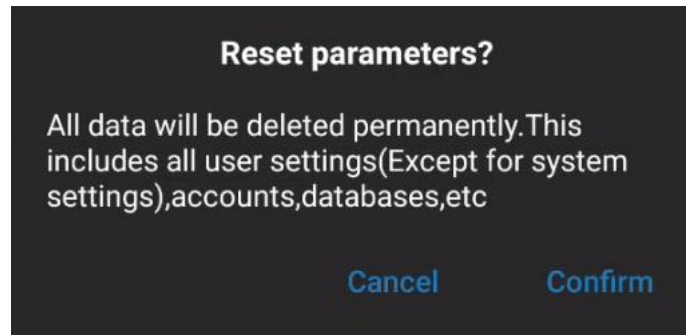

### 8.15. Image Annotations



You can use the annotation function to save additional information for the images, which can also be edited in the device. Annotations are the supplement to the basic information of the image, including text annotations, voice annotations, and sketch annotations.

#### 8.15.1. Add Text Annotations

You can add a text annotation to an image following the below ways.

- Soft keyboard: Enter free-form text.
- Text OCR: Recognition of printed text by taking a photo, and automatic input of recognized text.
- QR code scanning: Scan the QR code to be identified, recognize it in real time, and automatically enter the identified QR code information.
- Preset text: Use preset text to quickly input and manage the preset text, see 17.1.1 Preset text for details.

**Please follow the below steps.**

1. Open the image in a gallery file.
2. Press the OK button and select  from the menu.
3. Select  (Text annotation), and a dialog box will pop up, including text display area,  (Text OCR),

 (QR code scanning),  (Preset text),  (Quickly add preset text), and  (Save).

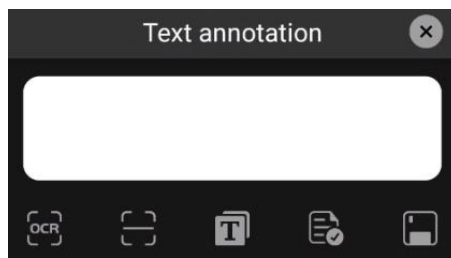

4. Follow these steps to enter free text using the soft keyboard.

(1) Press the OK button to bring up a soft keyboard where you can enter the text you want to save by touching the screen.

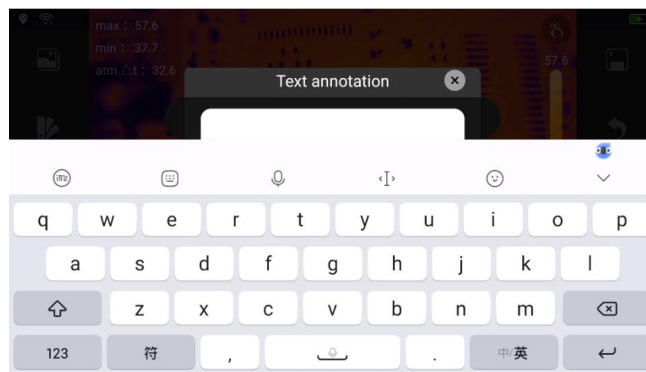

(2) After completion, touch  on the soft keyboard to return to the dialog box.

5. Follow these steps to enter text using text OCR.

(1) Use the joystick to select , and then press the OK button to enter the camera interface.

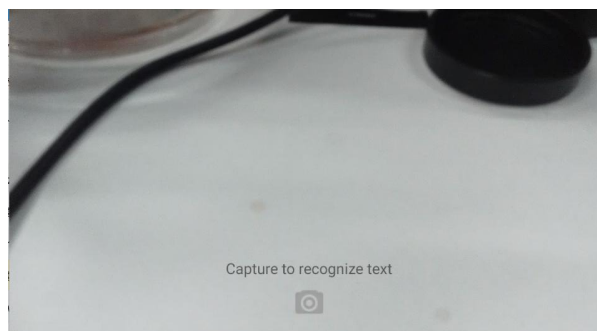

(2) Touch  to take the photo for OCR.

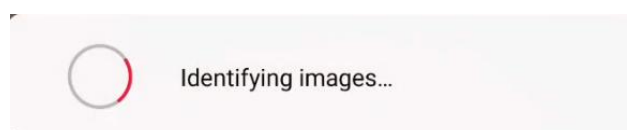

(3) The identified text will automatically fill in the text box.





6. Please follow the steps below to enter text by scanning the QR code.

- (1) Use the joystick to select  , and press the OK button to enter the QR code scanning interface.
- (2) Move the thermal imager to scan the QR code and make sure the image is clear.
- (3) The text box will be automatically filled in when the QR code is recognized successfully.

7. Follow these steps to input preset text.

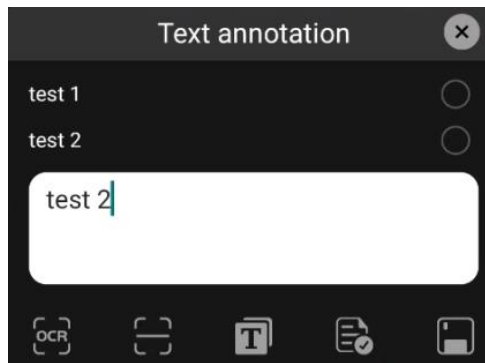
- (1) Use the joystick to select  , and press the OK button to display the preset text list.



- (2) Touch  to confirm the preset text, and the symbol will change to . You can select one or more.

- (3) The preset text will automatically fill in the text box.



8. Use the joystick to select  to save.

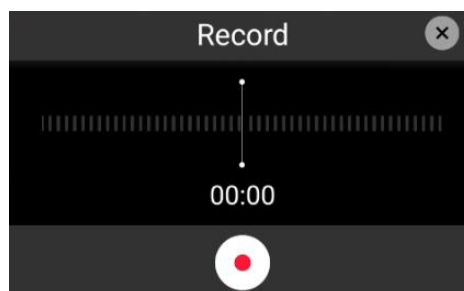

### 8.15.2. Add Voice Annotations

A voice annotation is an audio recording that is saved to an infrared image. Recordings can be played back in the camera and used in the PC software. You can use a Bluetooth headset to record voice annotations. For connecting a Bluetooth headset, see 17.6.3 Bluetooth Pairing.





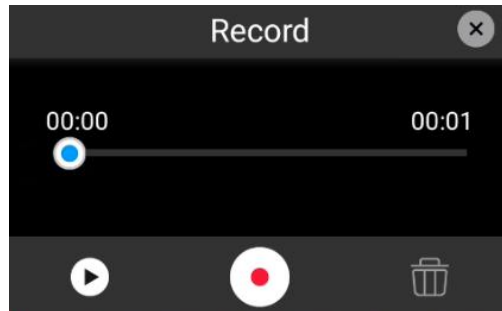

**Follow these steps.**

1. Open the image in a gallery file.
2. Press the OK button and select  from the menu.
3. Select  (Add Voice Annotation), and then press the OK button.

4. Select  (Record) and press the OK button to start recording.
5. Select  (Stop) and press the OK button to stop recording.
6. Select  (Pause) and press the OK button to pause recording.





7. Select  (Play) and press the OK button to listen to the recording.
8. Select  (Delete) and press the OK button to delete the recording.
9. Select  (Record) and press the OK button to re-record.
10. When finished, select  (Done) and press the OK button.

### 8.15.3. Add Sketch

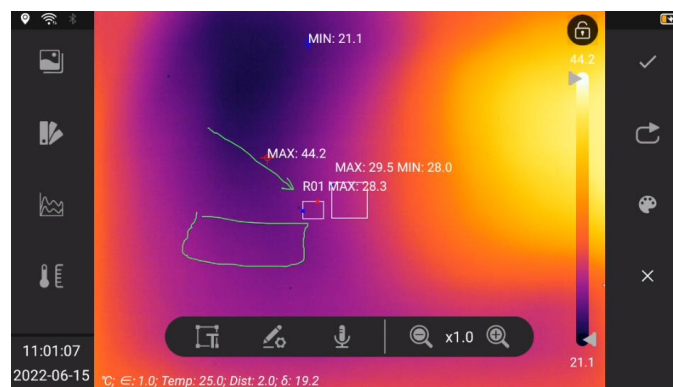
You can add a hand-drawn graphic to an image.



#### Follow these steps.

1. Open the image in a gallery file.
2. Press the OK button and select  from the menu.
3. Select  (Add Sketch), then press the OK button, and a secondary menu will pop up on the right side of the screen.
4. Select  (Palette), then press the OK button, touch the pop-up palette in the center of the screen,

and select a color.

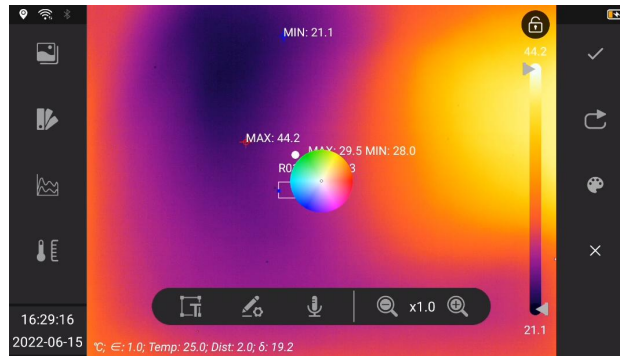

5. Sketch by touching the screen in sketch mode.

6. Select  (Cancel) and press the OK button to undo in a single step.

7. Select  (Save) and press the OK button to save the current sketch.

8. Select  (Clear) and press the OK button to clear the unsaved sketches.

## 9. Recording Settings

### 9.1. Video Recording

You can record and save video clips to memory card.

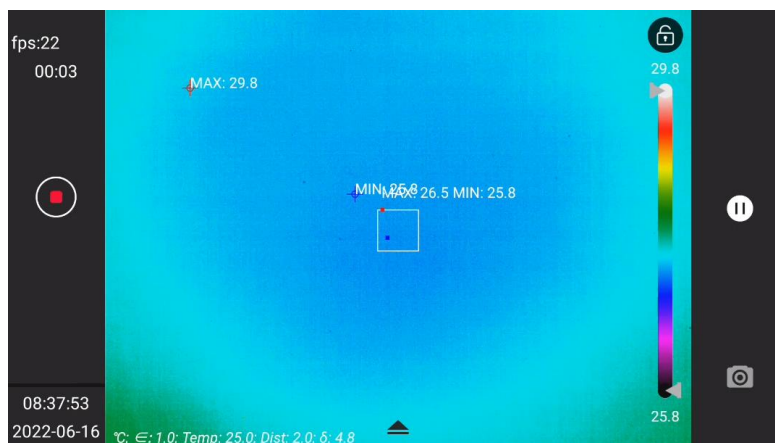



**Note:** The camera can be configured to save video in \*.mp4 or \*.irv format. Select  (Settings) > Function Settings > Video Format.

- MP4(\*.mp4): the file cannot be edited after the it is saved.
- Infrared data compression storage (\*.irv): Lossless compression storage and preservation of infrared





data. Support complete radiometric infrared data analysis functions with system software. This file does not contain any visible light image information. When recording video with this setting, only thermal imaging mode is supported.

- MP4(dual-spectral mode): record both infrared and visual image, the secondary analysis is unavailable.



### Follow these steps.

1. Long press the camera button to start video recording.
2. Carry out the following.
  - (1) Touch  (Stop), the back button or long press and then release the camera button to stop recording.
  - (2) Touch  (Pause) to pause recording.
  - (3) Touch  (Take Photo) to take a photo.
3. The recording will be automatically saved to a file and you can play it in the gallery.



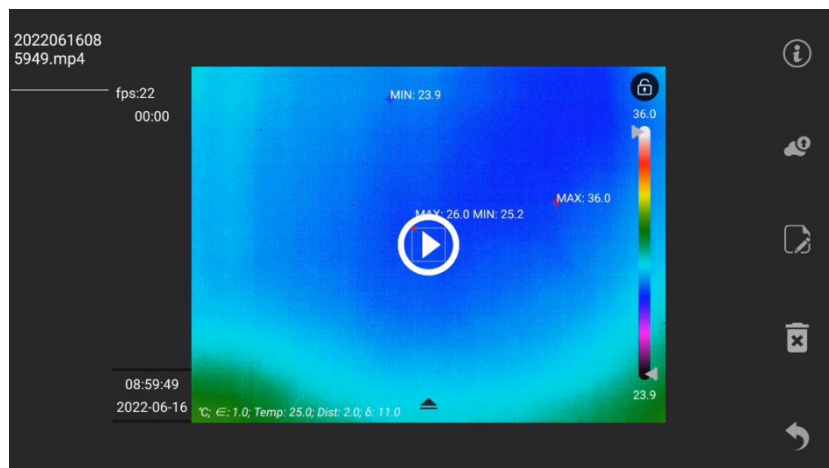

## 9.2. Video Processing

You can view and process videos in the gallery, including  (detailed info),  (upload cloud),  (rename),  (delete), and  (return).



- Touch the center of the screen  (play) to enter the video playback interface.
- Select  (Detailed info) to view video properties, including file name, file size, date, resolution, duration, and storage path.
- Select  (Upload Cloud) to upload the video file to the cloud. To log in to the cloud platform, see

13 Cloud Platform.

- Select  (Rename) to rename the file, including the text display area,  (Text OCR),  (QR code scan), and  (Save).

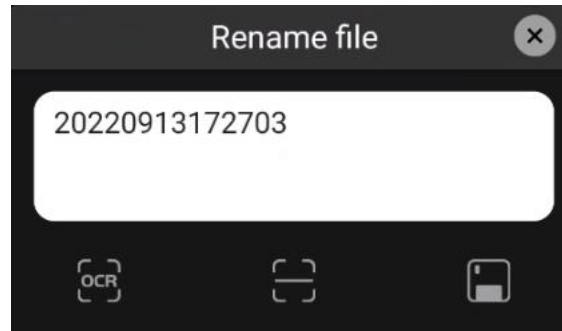

## 10. Image Effect Adjustment

It usually requires one or several parameters to get a good image.

- Adjust the focus of the thermal imager manually or electrically.
- Adjust the infrared image by automatic or manual mode.
- Select an appropriate temperature range for the target temperature distribution.
- Choose an appropriate color palette.
- Modify the environment variable parameters.
- Calibrate the thermal imager manually.

The following sections explain how to change these settings. In some scenarios, overlay information can be hidden for better viewing.

### 10.1. Thermal Camera Focusing

Focusing is very important, and the wrong focus will not only affect the captured image, but also greatly affect the temperature measurement accuracy.

You can adjust focus by the following ways.

1. The focus can be adjusted manually by rotating the focus ring. For more information, see 7.6 Manually Adjusting Camera Focus.
2. Autofocus by pressing the button.

The camera can also be set to continuous autofocus. See 7.8 Auto Center Focus for more information.

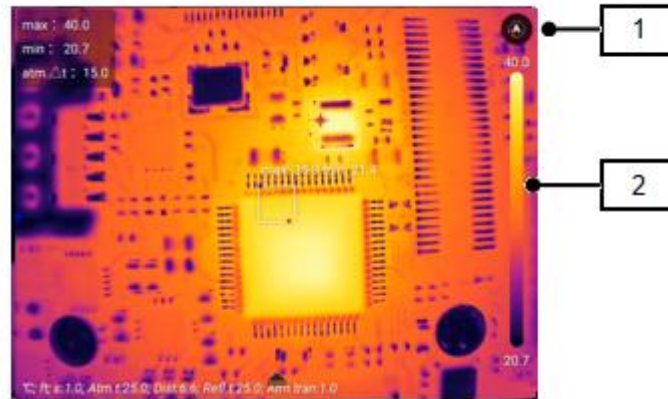

## 10.2. LEVEL and SPAN Adjustment



No.	Item	Functions
1	Switch Mode	Switch Level/Span mode
2	Scale	Display the temperature range of the current palette mapping, and the scale displays the temperature range of the current image

By clicking , you can switch the level/span mode, and adjust the infrared image in automatic or manual mode to obtain different image effects.

Status Description:

Status	Comments
	Auto level/span
	Manual level/span
	One-shot level/span adjustment
	MIN/MAX level/span adjustment



In automatic mode, the image is adaptively adjusted according to scene changes for the best image presentation. The temperature scale bar on the right side of the screen displays the temperature

range of the current scene, and the endpoints are the maximum and minimum values.



In manual mode, you can adjust the temperature to a value close to that of a specific object in the image, improve the contrast of ROI image, highlight anomalies and analyze small temperature differences. In this mode, distribute from the lowest temperature to the highest temperature evenly (linear color distribution) by changing the color.

Method for setting manual adjustment mode.

- Level adjustment: Move the joystick up and down. Moving up is to increase the maximum and minimum temperature at the same time, and moving down is to decrease the maximum and minimum temperature at the same time. You can also make adjustment by sliding up and down on the touch screen.
- Span adjustment: Move the joystick left and right. Moving left is to decrease the maximum temperature and increase the minimum temperature, and moving right is to increase the maximum temperature and decrease the minimum temperature. You can also make adjustment by sliding left and right on the touch screen.



In single-touch LEVEL/SPAN adjustment mode, you can click anywhere on the screen to adjust the contrast at the specified location for optimal viewing.



MAX/MIN: on the touch screen, touch two ends of the scale with your fingers to enter the selection status, swipe up and down the scale with your fingers to change the upper temperature limit and lower temperature limit.

### 10.3. Temperature Measurement Range

The thermal camera can be configured to adjust the temperature measurement range to adapt to scenarios with different temperature distributions. If not adaptive, it's required to change the temperature range according to different application scenarios.

**Note:** Adaptive temperature measurement is applicable, but it will affect your imaging. For example, when the object in the image is beyond temperature measurement range, you need to set it to manual adjustment if you do not want to switch range.

**Follow these steps:**

1. Use the joystick to go to  (Settings) and press the Ok button to display the settings menu.
2. Select the manual temperature measurement range.

3. Select the desired temperature measurement range and press the OK button.

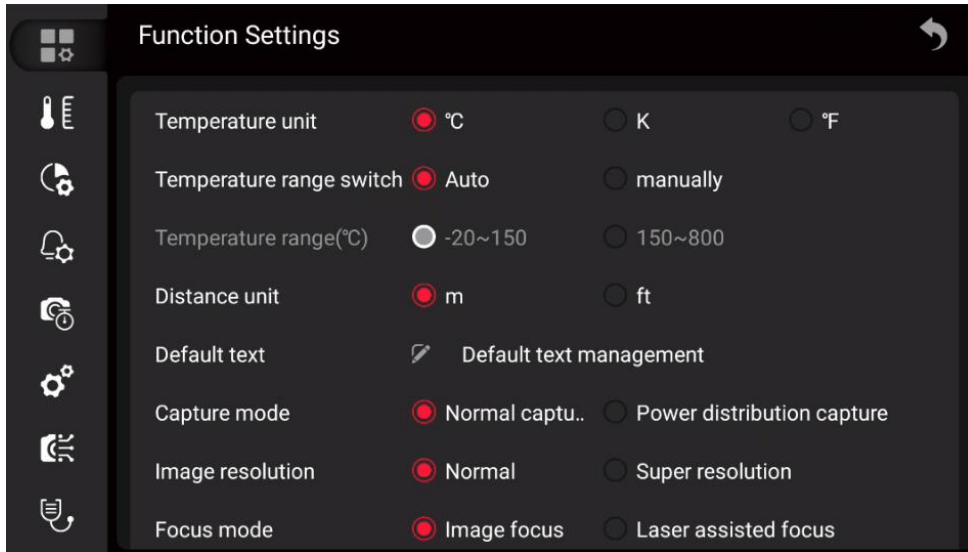

#### 10.4. Changing the color palette

You can change the color palette that the camera uses to display different temperatures. A different palette can make it easier to analyze an image.





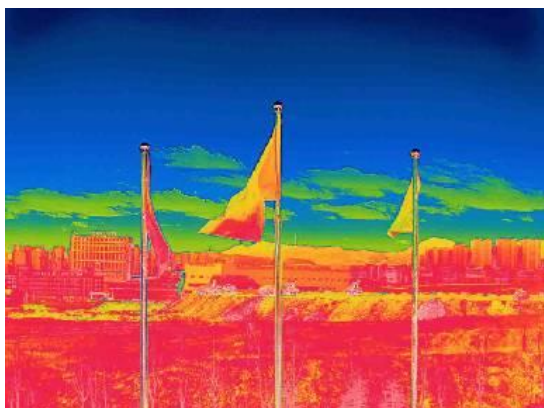

Rainbow

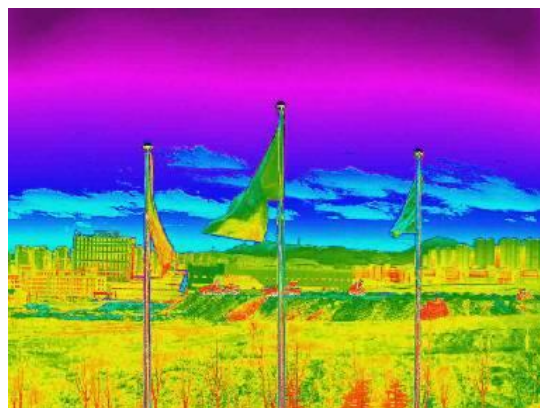

HC rainbow



Iron



Lava



Sky

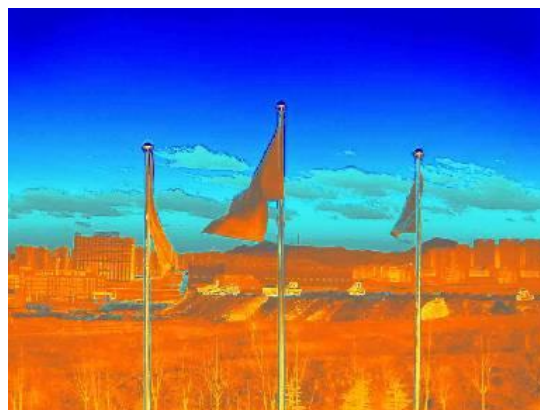

Ash

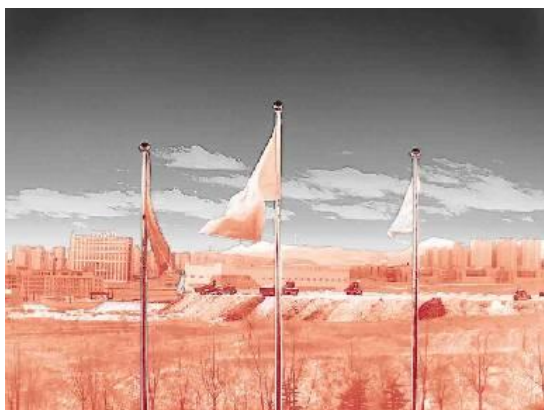

Gray-red



Hot iron



Special 1

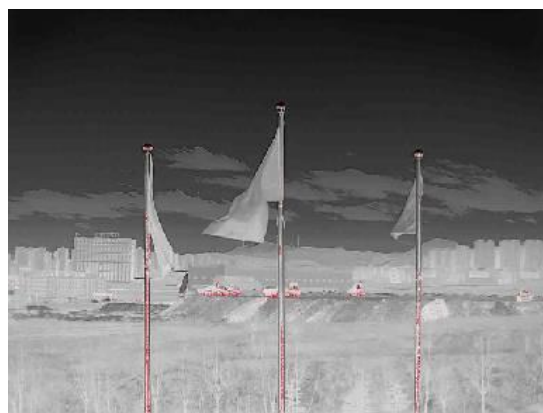

Warning red

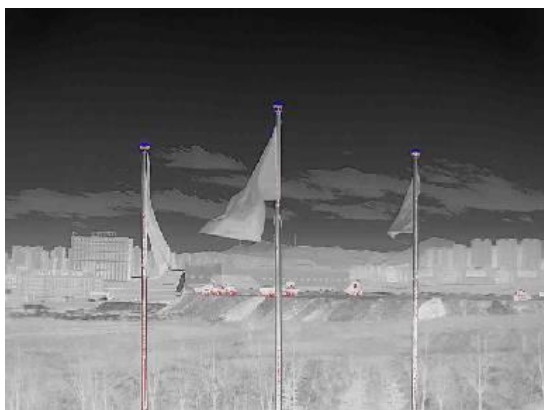

Ice fire



Green red

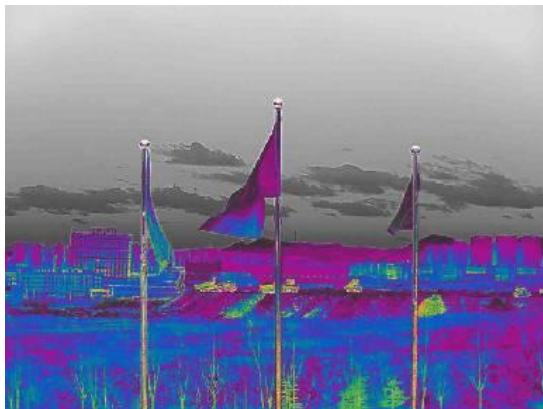

Special 2



Gradient red

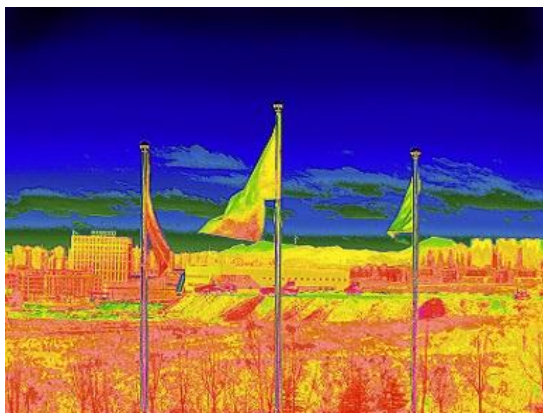

Medical

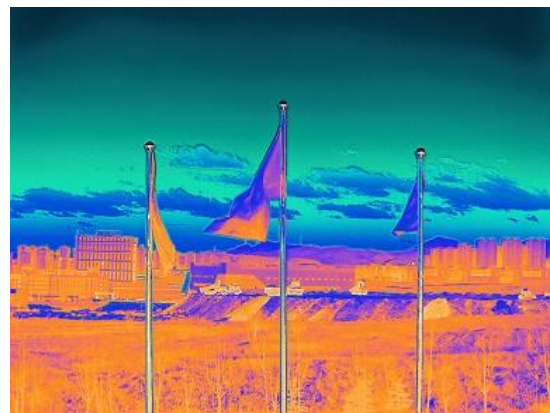

Multicolor

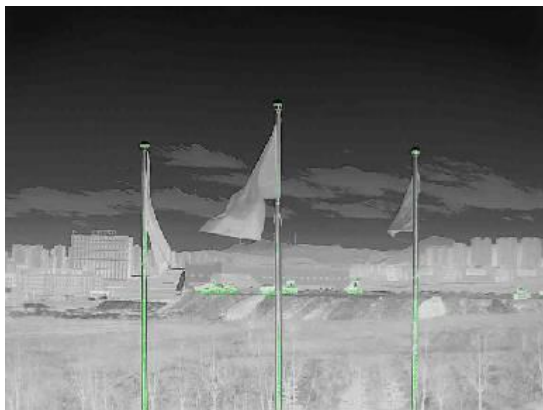

Warning green

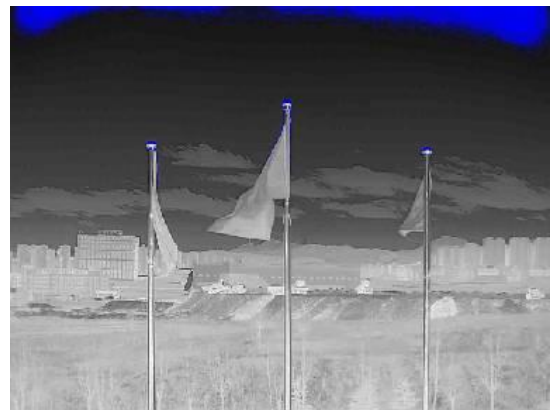

Warning blue

**Please follow the below steps.**

1. Use the joystick to go to  (Palettes).
2. Press the OK button to enter the submenu.
3. Use the joystick to select a different color palette.
4. Press the OK button to confirm.



### 10.5. Changing the environmental parameters

For accurate measurements, it is important to set the environmental parameters: emissivity, reflected temperature, distance, atmospheric transmittance, and atmospheric temperature.





You can set global parameters or set the environment parameters of analysis tools separately. See 11.5 Changing Analysis Tool Properties.

### 10.6. Image Calibration

Image calibration is to perform non-uniformity calibration (NUC) on the detector, which is a software-based image correction to adjust for the deviation in response of each individual detector element(pixel).

When the thermal image is superimposed with noise generated by non-uniformity, the quality of the image is deteriorated. Image correction is required, which is automatically calibrated by the thermal camera. Corrections can also be performed manually, such as before starting video recording or after focusing.

Manual correction can be done in several ways.

- Use the joystick to select and press .
- Tap  on the touch screen.
- Press the Gallery button  for more than 2 seconds.

### 10.7. Set Image Mode



The thermal camera captures both thermal and visible light images, and you can choose the type of image you want to display on the screen by setting the image mode.

Four different picture modes are available.

- **Thermal:** thermal images
- **Fusion:** an image in which the infrared image and the visible light image are fused in a certain proportion.



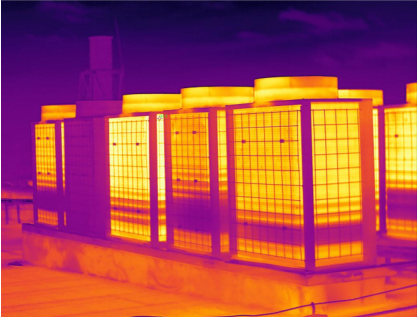

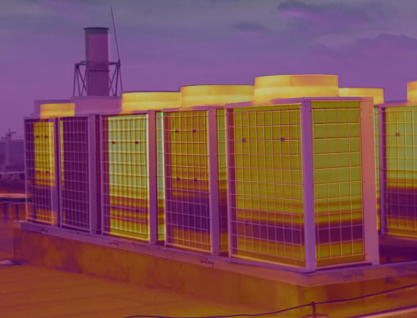
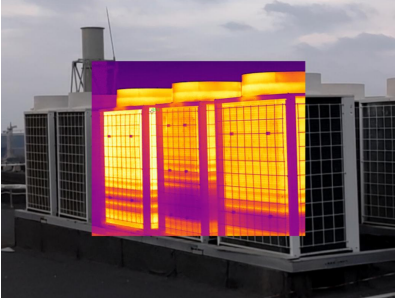

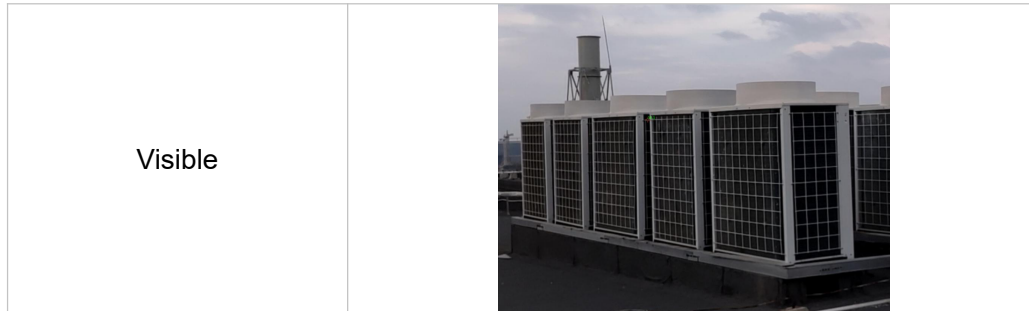
- **PIP**: an infrared image is shown above the visible image.
- **Visible**: visible light images
- **DDE**

The different types of image modes are shown in the table below.

Image Mode	Image Effect
Thermal	
DDE	
Fusion	
PIP	



**Please follow the below steps.**

1. Use the joystick to go to  (Image Mode).
2. Press the OK button to enter the submenu.
3. Use the joystick to select different mode (thermal), (fusion), (PIP), (DDE) and (visible).

**Note:**

- (1) If \*.irv video format (Settings>Function Settings>Video Format=IRV, and Recording Mode Video are selected, only thermal imaging mode can be selected.
- (2) DDE mode is not available for some models.

4. Press the Ok button to confirm.

**Note**

- If Fusion mode is selected, you can change the thermal fusion ration from 0-100% via the scale.
- If PIP mode is selected, you can move or zoom the size of the infrared area by touching the selection area.
- If thermal fusion or DDE is selected, you can move the position of visible light image by touching the selection area, you can also restore to factory default settings via (  Settings>System Settings>Registration Parameters Reset).





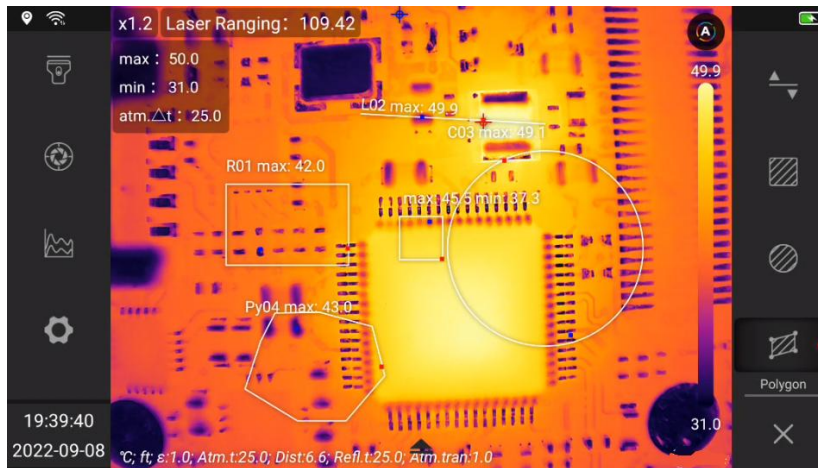







## 11. Analysis Setting

You can use one or more analysis tools at the same time to measure the temperature of the target.  
For example, spot temperature measurement, area temperature measurement.



## 11.1. Add/Delete Analysis Tools

Please follow the below steps.

1. Use the joystick to go to  (Analyze).
2. Press the Ok button to enter the submenu.
  - (1) Select  (spot temperature measurement) to add a spot temperature measurement analysis tool.
  - (2) Select  (line temperature measurement) to add a line temperature measurement analysis tool, click  to enable temperature trend function.
  - (3) Select  (rectangular area temperature measurement) to add a rectangular frame area temperature measurement analysis tool.
  - (4) Select  (circular area temperature measurement) to add a circular frame area temperature measurement analysis tool.
  - (5) Select  (customized polygon area temperature measurement) to add a customized polygon frame area temperature measurement analysis tool.
  - (6) Select  (Temperature Difference Analysis) to choose the analysis tool that requires temperature difference analysis.
  - (7) Select  (Cancel) to cancel the last added analysis tool.
  - (8) Select  (Clear) to clear all analysis tools.
  - (9) Select  (Import User Preset) to apply a set of user preset analysis tools. Please refer to 12.2 User Preset Settings. (Not applicable to some models)
  - (10) Select  (Export User Preset) to present a set of user preset analysis tools on the home screen.

(Not applicable to some models)



3. For resizing and/or moving analysis tools, see 11.3 Resizing or moving analysis tools.
4. For changing analysis tool parameters, see 11.5 Changing Analysis Tool.
5. Press the Back button, or select  (Return) to return to the first-level menu.

### 11.2. User Preset Settings



You can save a set of analysis tools to user presets for quick recall. User preset template can set the parameters of each analysis tool individually.

**Note:** importing user presets will clear the currently added analysis tools, and then import the preset analysis tool combination.

**Please follow the below steps.**

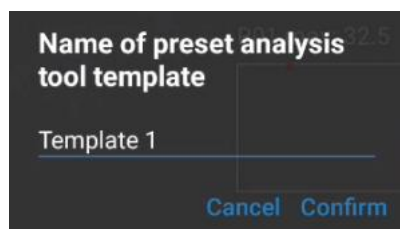
1. Use the joystick to go to  (Analyze), and press the OK button to enter the secondary menu.
2. Add/remove analysis tools to ensure that the analysis tools on the current screen are templates that meet the analysis requirements.
3. Select  (Export User Preset) and press the OK button to export all analysis tools on the current screen to the preset.
4. The dialogue box of preset will pop up, edit the name and click Confirm to save.



5. Select  (Import User Preset), press the Ok button to pop up the import dialogue box.
6. Select the template to be imported, and click  Confirm in the lower right corner of the dialog box.

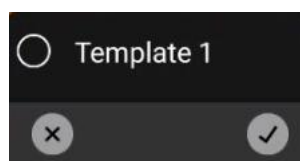



### 11.3. Move or Adjust Analysis Tools

You can move or resize analysis tools.

**Note:**

- If you have previously added analysis tools or user presets, you need to touch the screen to move and resize analysis tools.
- Temperature trend analysis is unavailable for some models.

**Please follow the below steps.**

1. Touch the analysis tool that needs to be adjusted or moved on the screen, the analysis tool will be highlighted, and a toolbar will pop up on the screen.

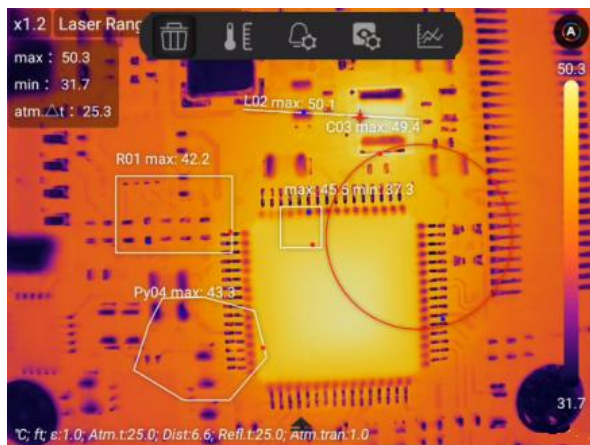

2. Move the joystick to switch functions, including: (delete), (area parameter), (alarm), (attribute), (temperature trend).
3. Select (Delete) to delete the currently selected analysis tool.
4. Select (Regional parameters), and a dialog box will pop up. Set the environment parameters of the currently selected analysis tool. Please refer to 11.5 Change Analysis Tools.

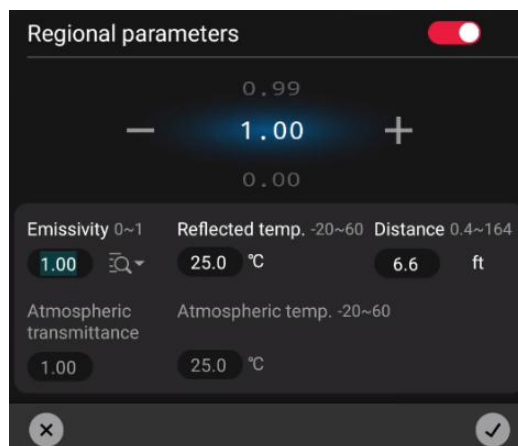

5. Select  (Alarm Settings), and a dialog box will pop up. Set the alarm parameters of the currently selected analysis tool. Please refer to 11.6 Set Analysis Tool Alarm.

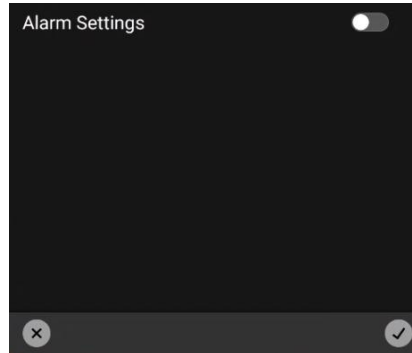

6. Select  (Properties), and a dialog box pops up. Set the properties of the currently selected analysis tool. See Analysis Settings in 11.5 Change Analysis Tool.

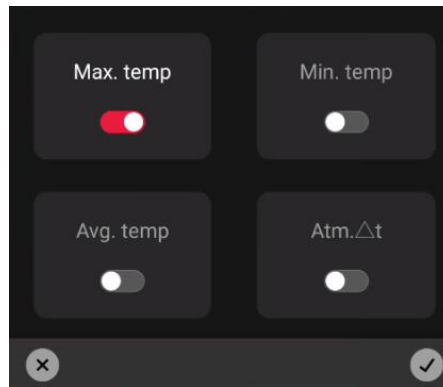

7. Select  (temperature trend) to pop up the temperature trend chart of the analysis tool, which records the temperature change of the analysis tool within 15 minutes, you can also save the temperature trend which you can replay or analyze by secondary analysis. (This function is unavailable for some models).

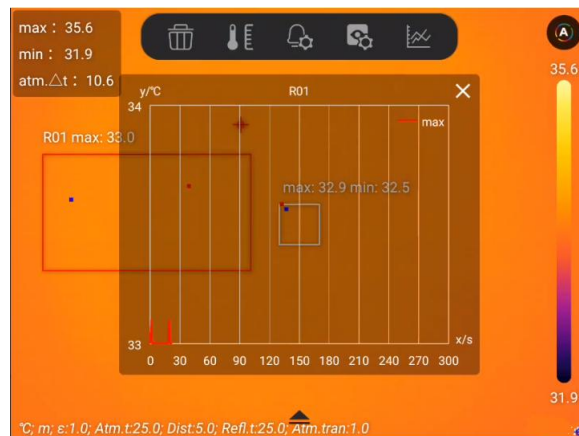

8. Touch the analysis tool to move on the touch screen.
9. Touch and drag the analysis tool to change the size.

### 11.4. Changing Parameters of Analysis Tool

To make accurate measurements, the analysis tool parameters must be set correctly.

#### 11.4.1. Parameter Type



The following parameters can be configured.

- **Distance:** the distance between the thermal camera and the target, you can click  to configure the distance via laser ranging module.
  - **Atmospheric temperature:** the temperature of the air between the thermal camera and the target.
  - **Reflected temperature:** which is used when compensating for the radiation from the surroundings reflected by the object into the camera. This property of the object is called “reflectivity”.
  - **Emissivity:** how much radiation an object emits, compared with the radiation of a theoretical reference object at the same temperature (called a “blackbody”). The opposite of emissivity is reflectivity. The emissivity determines how much of the radiation originates from the object as opposed to being reflected by it.
  - **Atmospheric transmittance:** the ratio of the flux of electromagnetic radiation that is attenuated by the atmosphere to the flux of incident electromagnetic radiation. Atmospheric transmittance is an important factor affecting infrared radiation transmission. The atmospheric pressure, humidity and gas density can change significantly in a short period of time where the atmospheric transmittance over a particular area is greatly affected by meteorology. So, the transmittance will change considerably as a result. The directly way is to measure the reference infrared radiation source such as the standard blackbody at a certain distance with infrared measuring equipment. The measured atmospheric transmittance at this distance is obtained according to the measured value of the blackbody, the radiance of the blackbody and the radiation responsiveness of the infrared equipment.
- Among the analysis tool parameters, emissivity is the most important parameter that needs to be set correctly. If the emissivity is set to a low value, the reflection temperature also becomes important. Distance, atmospheric temperature, atmospheric transmittance and reflected temperature are correlated when the distance is large.

### 11.4.2. Recommended Values

If you are not sure about these values, please follow the below recommended values.

<b>Distance</b>	2.0m
<b>Atmospheric Temperature</b>	25°C
<b>Reflected Temperature</b>	25°C
<b>Emissivity</b>	0.95
<b>Atmospheric Transmittance</b>	1.0

### 11.4.3. Change Parameters



You can set global object parameters, or modify parameters for each analysis tool separately, such as emissivity, reflected temperature, and distance.

**NOTE:** Setting global parameters is usually sufficient; the two most important parameters are emissivity and reflected temperature.

1. Please follow the below steps to modify global object parameters.

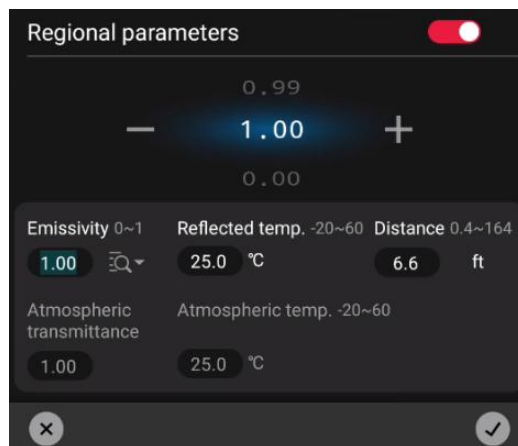
- (1) Use the joystick to go to  (Regional Parameters).
- (2) Press the OK button to pop up a dialog box.



- (3) Move the joystick left and right to switch parameters: emissivity, reflected temperature, distance, atmospheric transmittance, and ambient temperature.
- (4) Moves the joystick up and down to set the parameters.
- (5) Go to  and press the Ok button to confirm the modification and close.
- (6) Go to  and press the return key, cancel the modification and close.

2. Please follow the below steps to modify the parameter separately.

(1) To select an analysis tool, touch the analysis tool on the screen to bring up the toolbar.

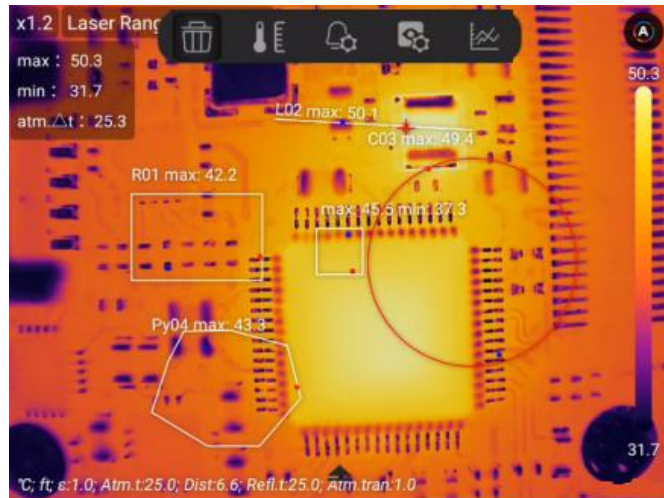

(2) Select  (Regional Parameters).

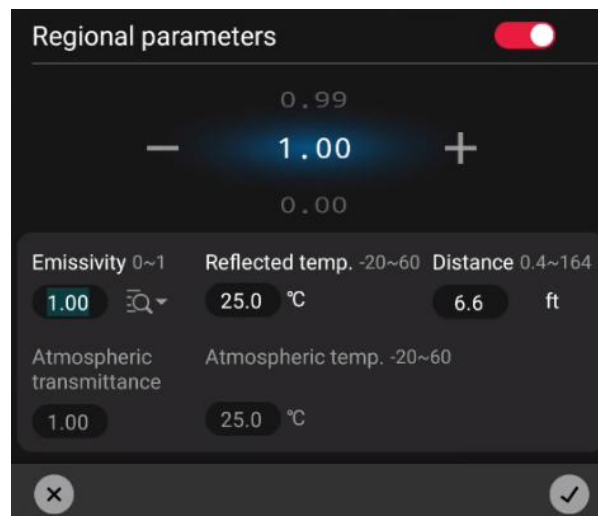

(3) Move the joystick left and right to switch parameters: emissivity, reflected temperature, distance, atmospheric transmittance, and atmospheric temperature.

(4) Moves the joystick up and down to set the parameters.

(5) Go to  and press the OK button to confirm the modification and close.

(6) Go to  and press the return key, cancel the modification and close.



## 11.5. Change Properties of Analysis Tool

You can set the properties of the analysis tool separately, including maximum temperature, minimum temperature, average temperature, and ambient temperature difference. For line analysis tools, historical temperature information curves can also be displayed.

**Please follow the below steps.**

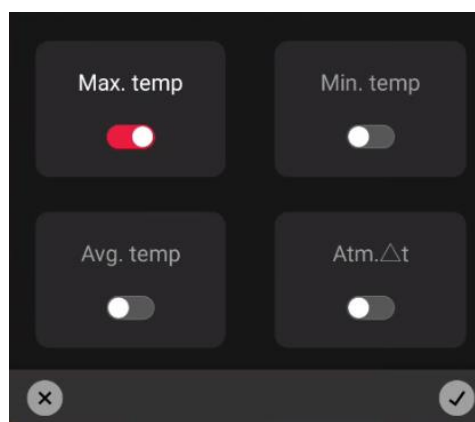
1. Touch the analysis tools on the screen.
2. Use the joystick to select  (Properties), a dialog box will pop up.



3. Move the joystick left and right to switch parameters: Max temperature, Min temperature, Avg temperature, and ambient temperature difference.
4. Enable or disable the display property.
5. Go to  and press the OK button to confirm the modification and close.
6. Go to  and press the return key, cancel the modification and close.

## 11.6. Set Analysis Tool Alarm





You can make the camera trigger an alarm when the set analysis conditions are met.

### 11.6.1. Alarm Type

You can choose the following alarm types.

- Above: When the temperature is higher than the preset alarm temperature, an alarm will be triggered.
- Below: When the temperature is lower than the preset alarm temperature, an alarm will be triggered.
- Interval: When the temperature is within the preset alarm temperature interval, an alarm will be triggered.

### 11.6.2. Alarm Signal

This symbol  is displayed in the results table when an alarm has been set by the analysis tool. When an alarm is triggered, the attribute values in the result table are displayed in red (above the preset alarm), blue (below the preset alarm) and green (preset alarm of the ambient temperature difference), symbols  (above the preset alarm),  (below preset alarm) and  flash (preset alarm of the ambient temperature difference) flash.

You can also set an audible alarm (you will hear the wailing of police siren when the alarm is triggered) or a snapshot of the alarm.

### 11.6.3. Alarm Settings

Please follow the below steps to set alarming.

1. Touch the analysis tool on the screen and make sure at least one property is enabled. Max temperature, Min temperature, Avg temperature, and atmospheric temperature difference.
2. Use the joystick to select  (Alarm Settings), and a dialog box will pop up.

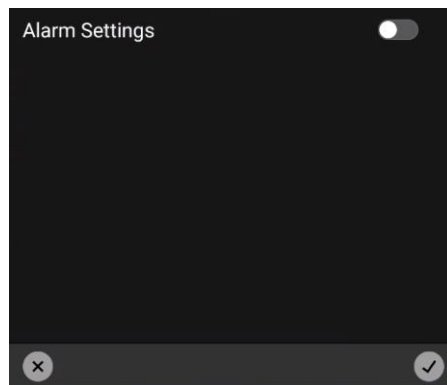

3. Touch  to enable the alarm settings.

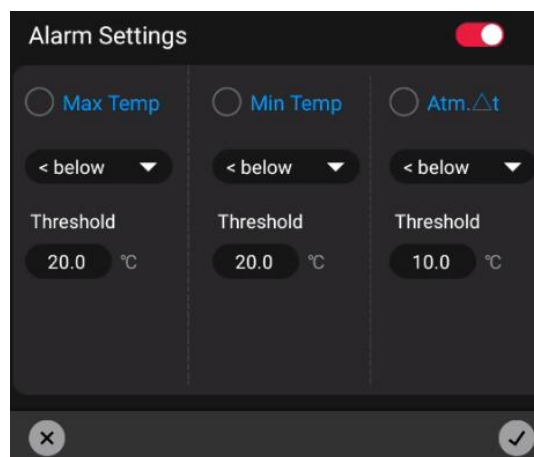

4. Move the joystick left and right to switch parameters: Max temperature, Min temperature, Avg temperature, and atm. temperature difference.
5. Move the joystick up and down to enable or disable the display of this property.
6. Press the OK button to confirm the modification and close.
7. Press the back key to cancel the modification and close.

You can also make batch settings in settings. See 17.3 Analysis Settings.



### 11.7. Isotherm

By setting isotherm, anomalies can be easily spotted in infrared images. Apply isotherm for pixels in the image that are above, below, and below the set temperature with a contrasting color.

The camera can be set to trigger the following types of color alarms.

- Above alarms: This will apply a contrasting color to all pixels whose temperature is above the specified temperature threshold.
- Below alarms: This will apply a contrasting color to all pixels whose temperature is below the specified temperature threshold.
- Interval alarms: This will apply a contrasting color to all pixels with all temperatures between the two specified temperature thresholds.





**An example is as follows:**

Isotherm Type	Image Example
Above Alarm	
Below Alarm	





Please follow the below steps to set above alarm, below alarm, and interval alarm.

1. Use the joystick to go to isotherm .
2. Press the OK button to enter the secondary menu. Move the joystick to select the alarm type, above alarm , below alarm , interval alarm .
3. Press the OK button, the threshold temperature will be displayed on the temperature scale on the right side of the screen.
4. To change the threshold temperature:
  - (1) For interval alarm, move the joystick left/right to select low/high temperature value.
  - (2) Move the joystick up and down to change the threshold temperature.
  - (3) You can press and hold the cursor to pop up a dialogue box and type in the threshold you want.

## 12. Remote Connection and Control

You can connect the thermal imaging camera to a computer or phone via USB cable or Wi-Fi, and obtain image, video and real-time access to the infrared data stream and analysis through the software.

**Please follow the steps:**

1. Swipe up-down on the screen with the finger to unfold the shortcut tools bar.
2. Go to  Data Sharing via joystick button and press Ok button.
3. It will display Please Connect Wi-Fi or USB devices if the device has not been connected.
4. A prompt window will pop up if the device has been successfully connected.

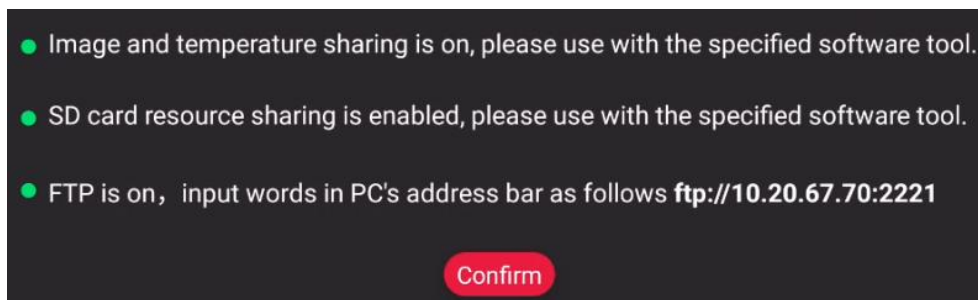

- (1) Visit Gallery File: You can visit the gallery data via PC software or mobile App. You can also visit the gallery via the FTP service of third-party software, please refer to Chapter 15.
- (2) Projection Screen: The real-time image can be viewed via PC software or mobile App. You can also video the image via the third-party software which supports RTSP protocols.
- (3) Real-time temperature analysis: The temperature acquired from the PC software or mobile APP can be analyzed simultaneously.

5.Tab the Data Sharing again to end the service.

### 13. Cloud Platform

Cloud platform can be used to upload and download data to improve data management efficiency, as well as for secondary analysis and remote connection to reduce work complexity and make data analysis more flexible.

**Note:** *this function is unavailable for some models.*

**Please follow the below steps.**

1. Slide down to expand the shortcut toolbar.
2. Use the joystick to go to  (Cloud Platform) to login.

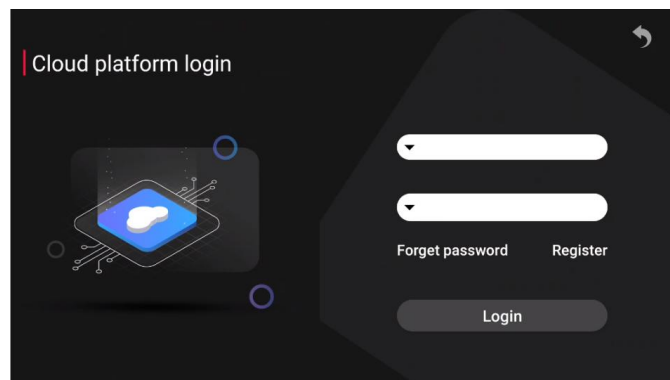

3. After clicking Login, you can connect to the cloud platform. Internet connection is necessary to use the cloud platform. For internet connection, please refer to 17.6.1 Connecting to WLAN.

### 14. Wireless Projection

You can cast the screen of the current device to other large screens in the network that support the Miracast protocol.

Please follow the below steps.

1. Swipe down to unfold the shortcut toolbar.

2. Use the joystick to go to  (Wireless Projection) to open the dialog box.

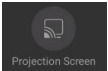

3. Select a large screen that can be connected to perform screen projection in the dialog box.

4. Touch  (Wireless Projection) to turn off projection.

## 15. FTP

You can configure the thermal camera as an FTP server. Users can connect to the thermal camera to upload or download files through the FTP protocol.

**Note:** you can access data via anonymous FTP login, please change user name and password instantly.

Please follow the below steps.

1. Slide down to expand the shortcut toolbar.

2. Use the joystick to go to  (FTP) to start the dialog.

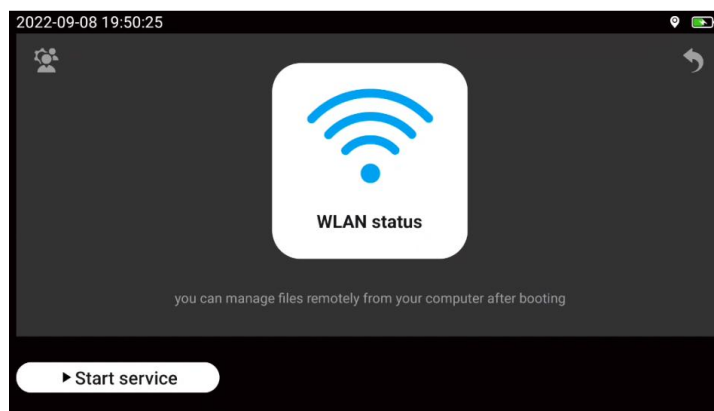

3. Touch  to pop up the username/password configuration dialog box.

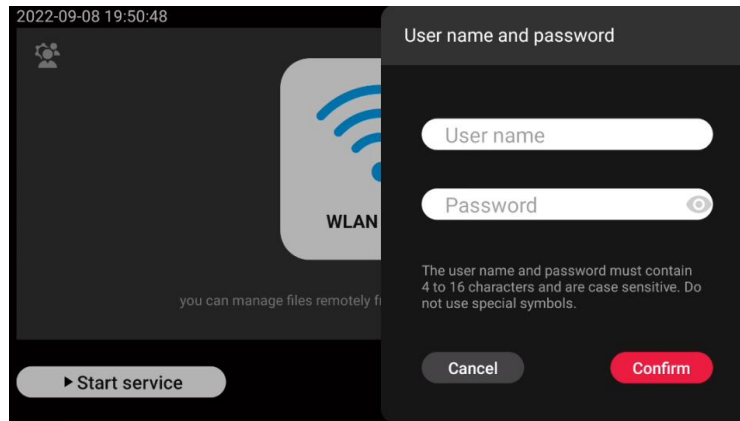

4. Touch Start Service to start the FTP service.

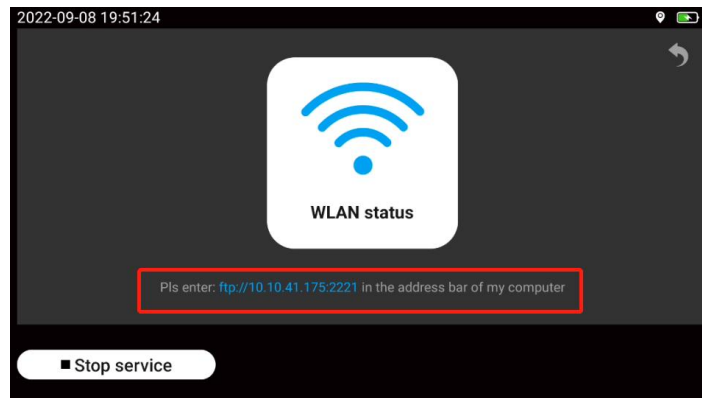

5. Touch Stop Service to stop the FTP service.
6. Follow the prompts to enter the FTP server address in the address bar of the PC, input the user name/password to enter the gallery, and make sure that the PC and the thermal camera are in the same local network.

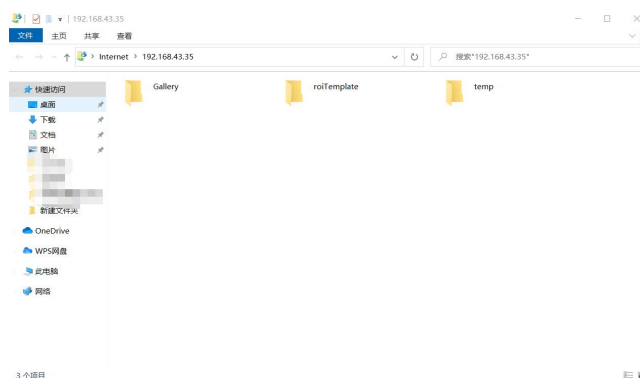

### 16. Data Sharing









By connecting the thermal camera to the PC through the data sharing, you can obtain the real-time temperature data stream and analysis tool settings of the thermal camera, and perform secondary analysis in the PC software.

**Note:** This function is available in PC software or mobile application, meanwhile, make ensure that the PC and the camera are connected and in the same local network.

**Please follow the below steps.**

1. Slide down to expand the shortcut toolbar.
2. Use the joystick to go to  (Data Sharing) to enable the service.

### 17. Settings

Settings can be changed in the thermal camera. The settings menu includes the followings.   
(Function Settings),  (Environmental Parameters),  (Analysis Settings),  (Alarm Settings),  (Time-lapse image capture),  (System Settings),  (Smart Capture),  ( Diagnostic Rules)

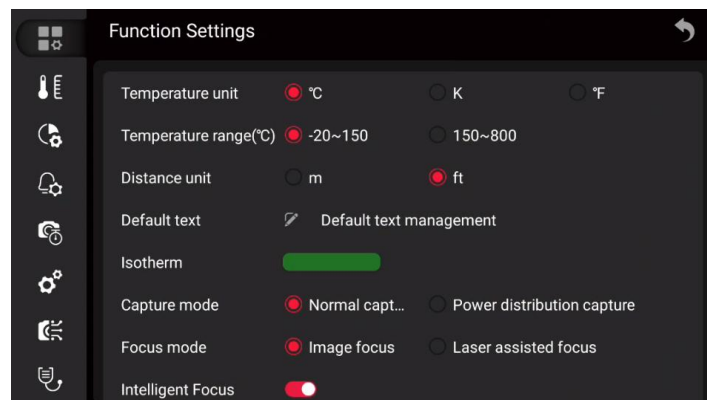

#### 17.1. Function Settings

Basic function settings, including temperature unit, temperature range switching, distance unit and other parameters. Default texts, filename prefixes, and report templates can be managed.

### 17.1.1. Default Texts

You can manage default text for image notes.

**Please follow the below steps.**

1. Use the joystick to go to Default Text Management and press the Ok button.

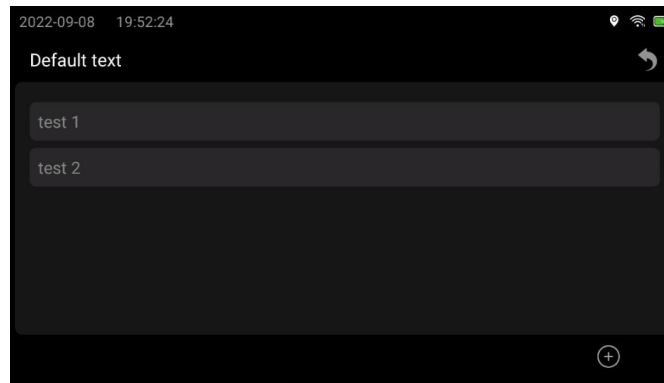

2. Touch  to start the dialog to add default text.

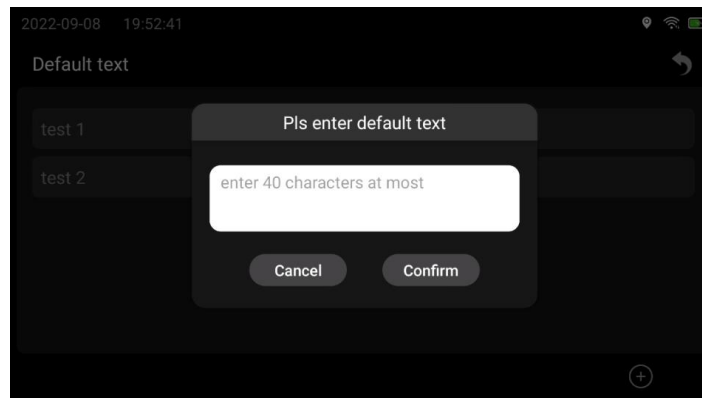

3. After entering the text, click OK to save.
4. Click the text, the toolbar will pop up, and click  to delete the default text.

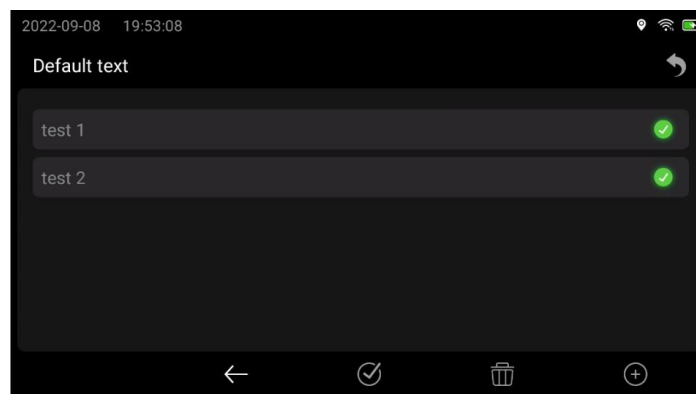

5. To delete all preset texts, click .

### 17.1.2. Filename Prefixes

You can customize the filename prefix of the image. Use the joystick to go to Edit Filename Prefix to enter the prefixes.

### 17.1.3. Edit Report Templates

You can edit templates for generating analysis reports.

**Please follow the below steps.**

1. Use the joystick to go to Edit Report Template, and press the joystick to enter the report template editing page.

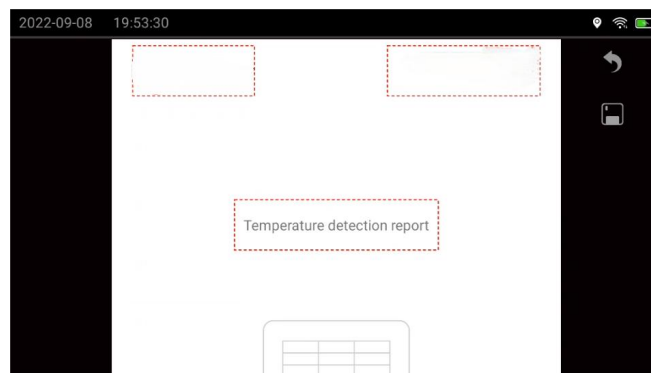

2. The contents in red dashed boxes can be edited, including Logo, page header, and title.
3. After editing, click  to save.

## 17.2. Environmental Parameters

To configure full frame ambient parameters, see 11.4 Change Analysis Tool Parameters.

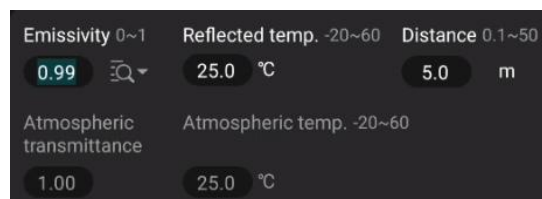

## 17.3. Analysis Settings

You can configure the properties of the whole frame and analysis tools, including the maximum temperature, center temperature, minimum temperature, and ambient temperature difference of the

whole frame; maximum temperature, average temperature, minimum temperature, and ambient temperature difference of analysis tools.

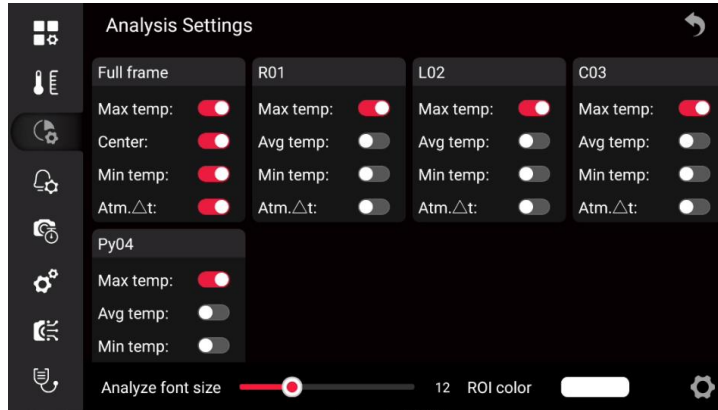

You can adjust the font size and border color of the analysis tool.

### 17.4. Alarm Settings

You can set alarm settings of analysis tools in batches and configure alarm linkage.

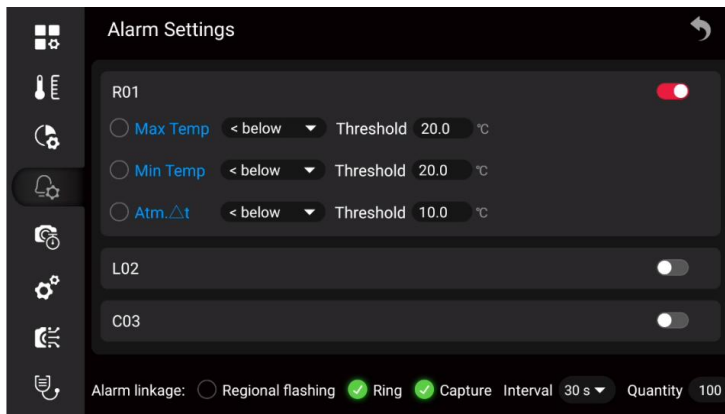

### 17.5. Time-lapse Image Capture

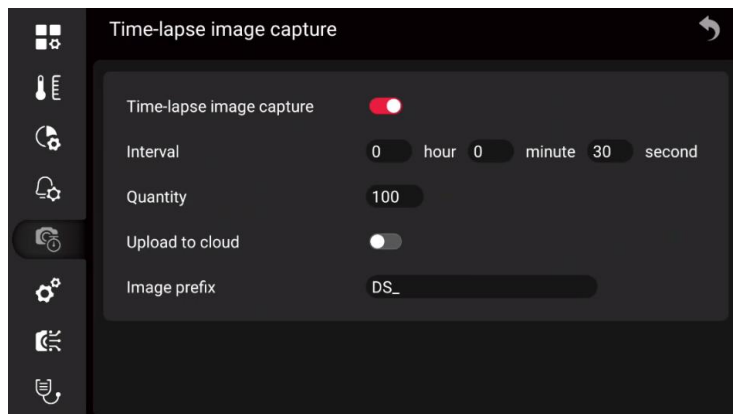

You can configure the thermal camera to save images in a timed (time-lapse) mode.



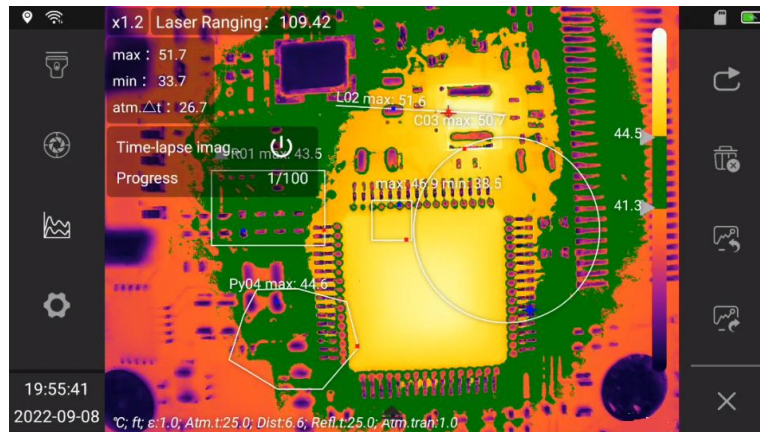





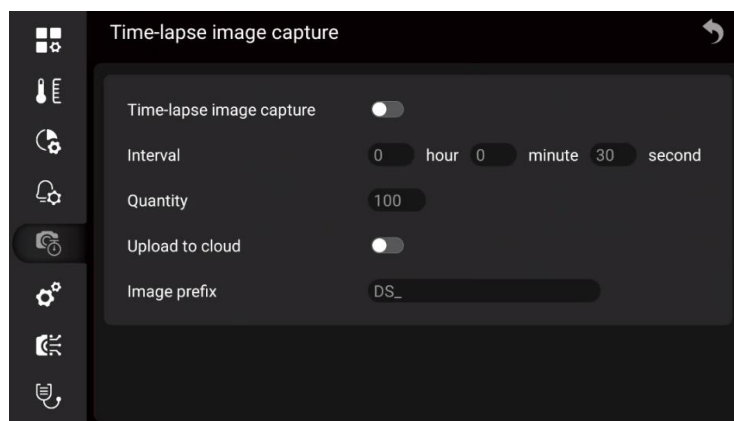

Please follow the below steps.

1. Go to  (Settings) via the joystick, and press the OK button.
2. Select  (time-lapse image capture) to enter the secondary menu to set parameters.



3. Time-lapse image capture:  (On) or  (Off).
4. Interval: Set the interval of capturing time-lapse images, ranging from 5s to 24 hours.
5. Quantity: The default is 100, ranging from 1 to 1000.
6. Upload to cloud: After enabled, the photos will be uploaded to the cloud by default. (Not available for some models)
7. Image prefix: Customize the prefix for time-lapse images, DS\_ by default.
8. To manually start or stop the time-lapse image capture, press the photo button, and you can also touch  (stop) to stop time-lapse image capture.

### 17.6. System Settings

You can view device-related information in the system settings, and perform connection settings and

device settings.

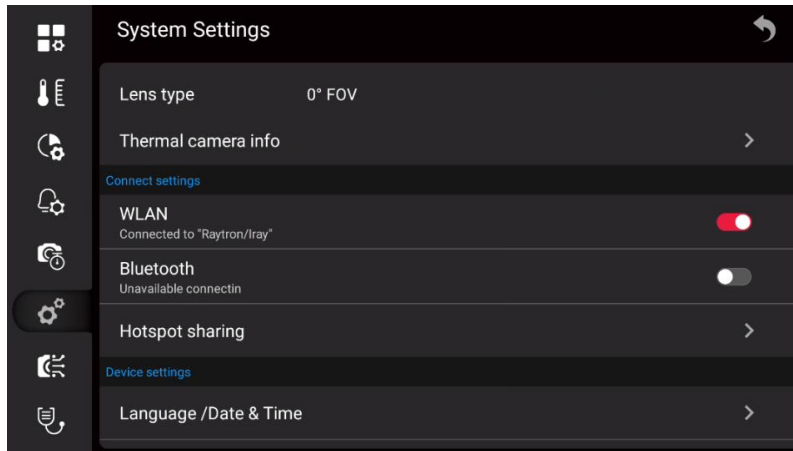

### 17.6.1. Wi-Fi Settings

You can connect the camera to a wireless local area network (WLAN) using Wi-Fi, or let the camera provide Wi-Fi access to other devices. The most common uses are as follows.

- Setting up the thermal camera as a wireless access point. This method is primarily used with mobile devices, such as Android or IOS mobile terminal.
- Connect the camera to a wireless local area network (WLAN). This method is primarily used for remote connection and control, cloud platform access.

**Note:** You can only choose one of these two modes.

**Please follow the below steps to connect to a wireless access point.**

1. Use the joystick to go to Hotspot Sharing, and then press the OK button.

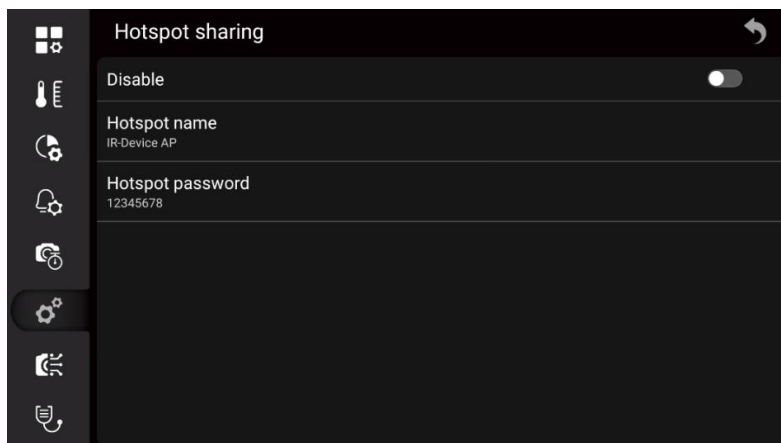

2. Touch to configure the hotspot name and hotspot password.
3. Touch the switch and the hotspot will be turned on.

Please follow the below steps to connect to WLAN.

1. Use the joystick to go to WLAN configuration, and press the OK button to enter the WLAN configuration list.

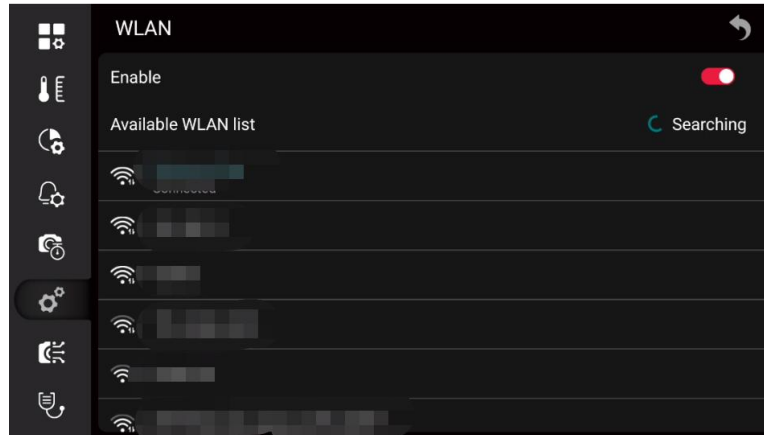

2. Use the joystick to go to , refresh the available WLAN list.
3. Select the network to be connected, and press the OK button to pop up a dialog box.

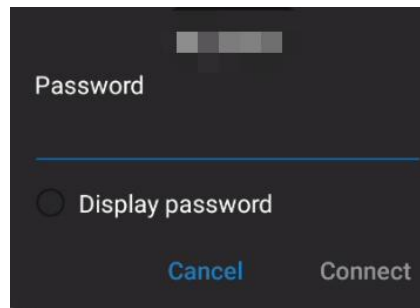

4. After entering the password, use the joystick to go to Connect and press the OK button to confirm.

### 17.6.2. Configure Mobile Data

Insert the SIM card before enabling this function.

**Note:** this function is unavailable for some models.

### 17.6.3. Bluetooth Pairing

Before using a Bluetooth device, it needs to be paired with the camera, which can be configured in the settings or in the shortcut bar.

Please follow the below steps to set it in the settings.

1. Use the joystick to go to Bluetooth, and then press the Ok button.

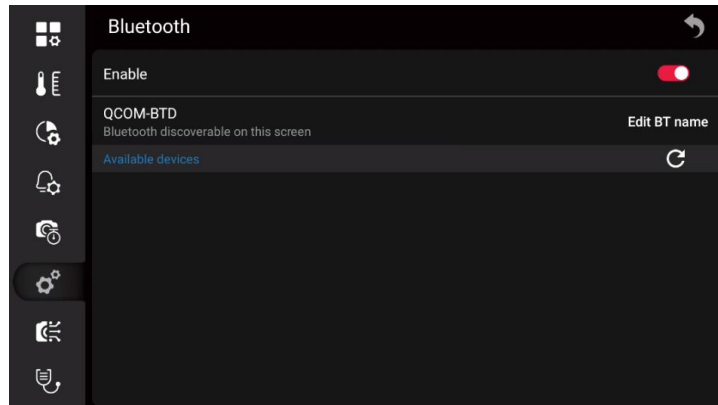

2. If the Bluetooth is off, press the OK button to activate Bluetooth.

**Note:** make sure the external Bluetooth device is available.

3. Select an available device and press the OK button.
4. It will take about 15 seconds to wait for the list of available devices to appear.
5. When a Bluetooth device is found, select the device to be added and begin pairing. Then, the device can be used.

**Note:** Only enabled Bluetooth headsets will appear in the list of available devices.

6. You can add several devices.
  7. You can remove the device by selecting Unpair Device.
  8. After adding a Bluetooth headset, it can be used to add voice annotations.
- For quick configuration in the shortcut bar, please refer to 6 Shortcut Toolbar.

### 17.6.4. Language and Date

You can select the language from hundreds of languages according to your language habits Use the joystick to go to Language Date & Time > Language.

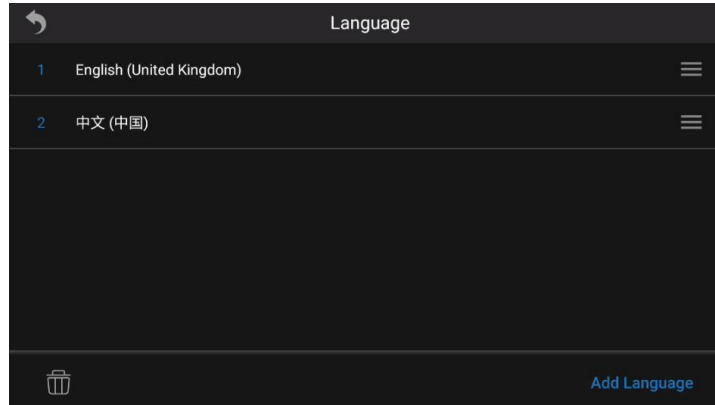

You can set the date and time, or synchronize via the network. In this case, you need to connect to the Internet. For networking operations, see 17.6.1 Connecting to WLAN. Use the joystick to go to Language Date & Time > Date & Time.

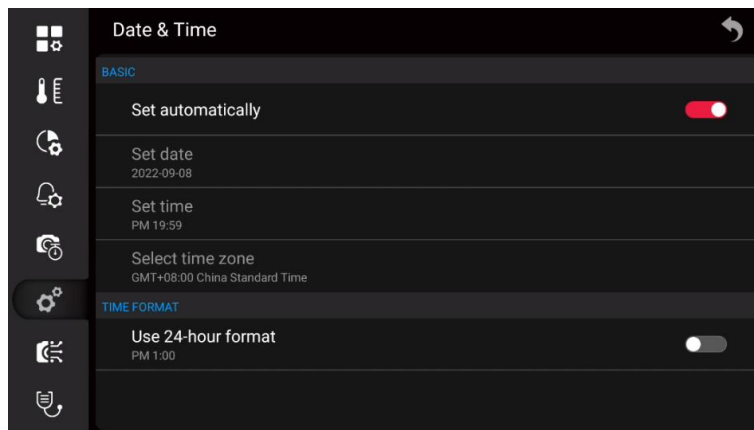

### 17.6.5. Auto Screen Timeout

You can set the automatic screen timeout time, and use the joystick to go to the automatic screen timeout. Never by default.

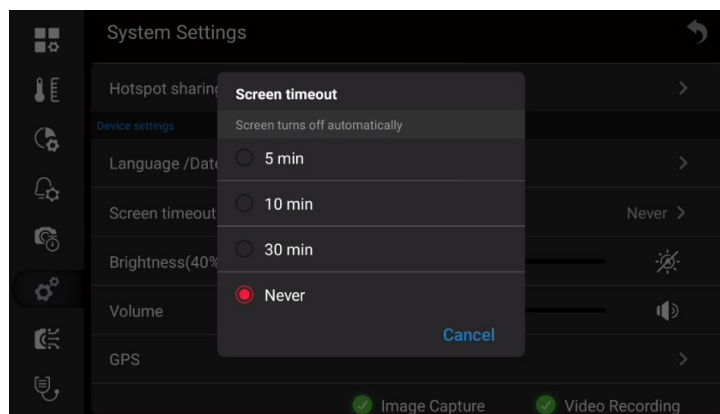

### 17.6.6. Brightness

The screen brightness slider is used to control the brightness of the screen., or you can enable automatic screen brightness.

### 17.6.7. Volume

The volume slider is used to control the volume.

### 17.6.8. GPS

You can turn GPS on or off, and you can see the location information after turning it on.

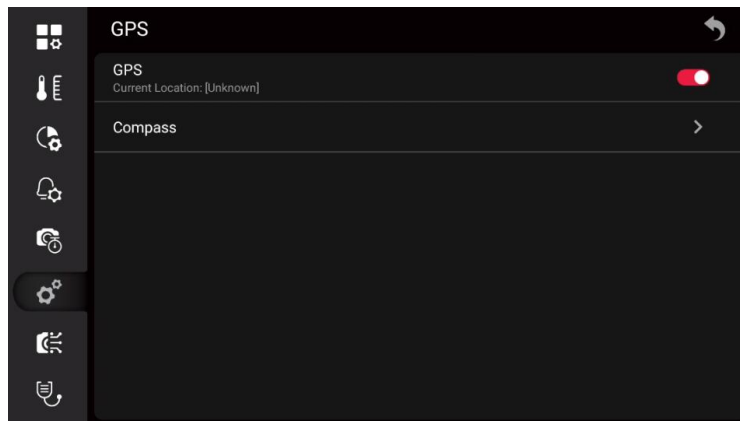

### 17.6.9. Virtual Buttons

After virtual buttons are enabled, you can use touch screen instead of physical buttons. The virtual buttons include Image Capture, Video Recording, Gallery, and Auto Focus.

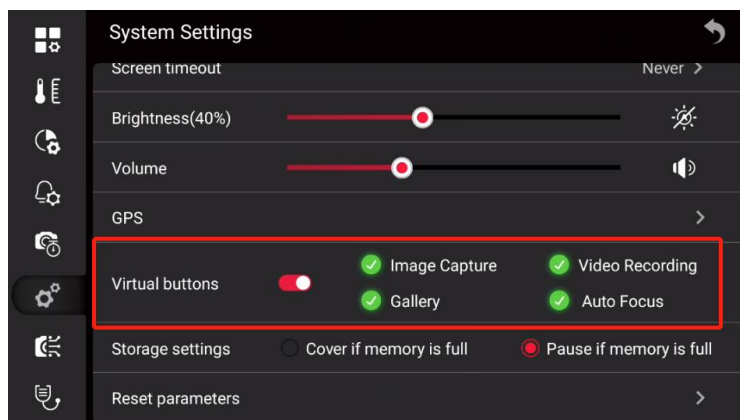

After the virtual buttons are enabled, the expansion toolbar can be woken up on the home screen. As shown in the following figure.

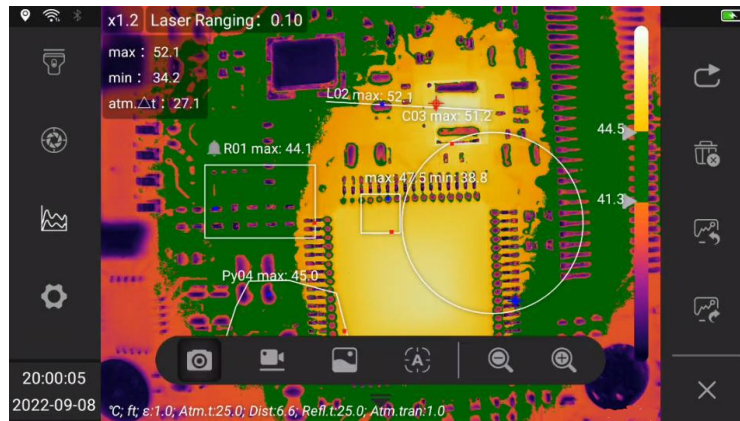

### 17.6.10. Storage Settings

There are two kinds of storage available, cover or pause if the memory is full.

- Cover if the memory is full: historical files will be covered. Taking pictures or videos at regular intervals will not be suspended, but it may overwrite useful files.
- Pause if the memory is full: when the card is full, tasks such as taking pictures and videos cannot be performed. You need to manually delete files or delete files in batches to continue.

### 17.6.11. External SD Card

You can perform the following operations on the SD card:

1. Eject SD card: Click  to eject the SD card.
2. Mount SD card: Click External SD card and select Mount to complete the mounting and use of the SD card.



3. Format SD card: Ensure the external SD card is mounted, click External SD card, select Format to complete formatting, and then remount it for use.

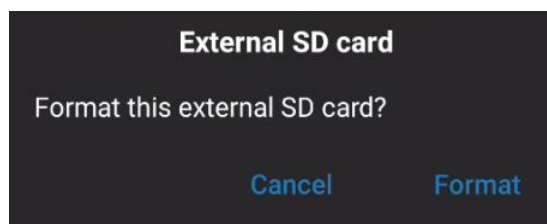

**Note:** Formatting the SD card will result in data deletion. Please proceed with caution.

### 17.6.12. Alignment Parameter Reset

You can click on *Alignment parameter reset* to restore the dual-spectrum alignment parameters to the factory settings.

### 17.6.13. Reset Parameters

You can clear customized settings by resetting the parameters.

**Note:** This operation will clear all customized settings, including customized settings, analysis tool configuration, palette, ambient parameters and other configurations. Wi-Fi, Bluetooth, images and other data are not affected.

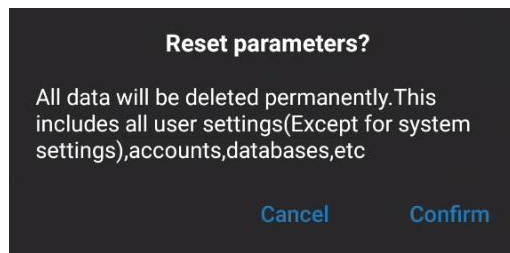

### 17.6.14. Factory Reset

You can reset your device to its factory state with a factory reset.

**Note:** This operation will clear all data, including images and other data. Please take cautions.

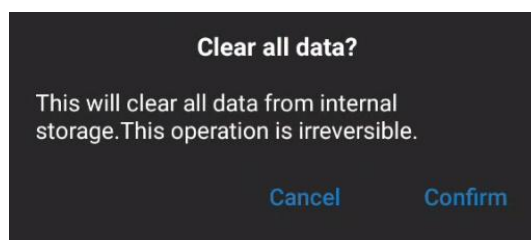

### 17.6.15. Software Update

You can choose online update (OTA) or update from SD card.

- OTA: The device should be connected to the Internet. For the network operation, see 17.6.1 Connecting to WLAN.
- Update from SD card: You need to copy the update file to the SD card. For details on obtaining the update file, please contact customer service.



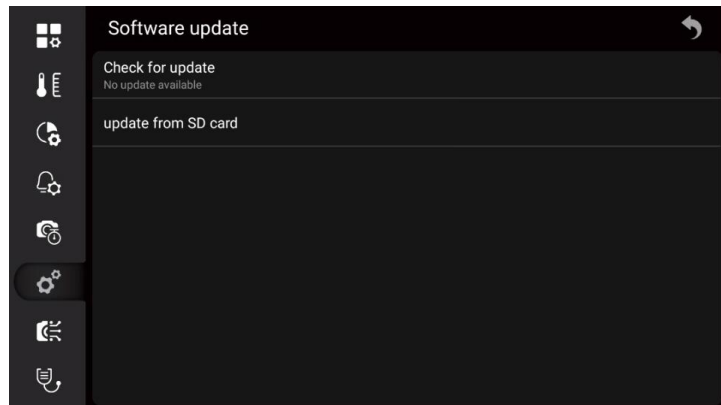

### 17.7. Smart Capture

You can import the smart capture package from SD card or cloud platform.

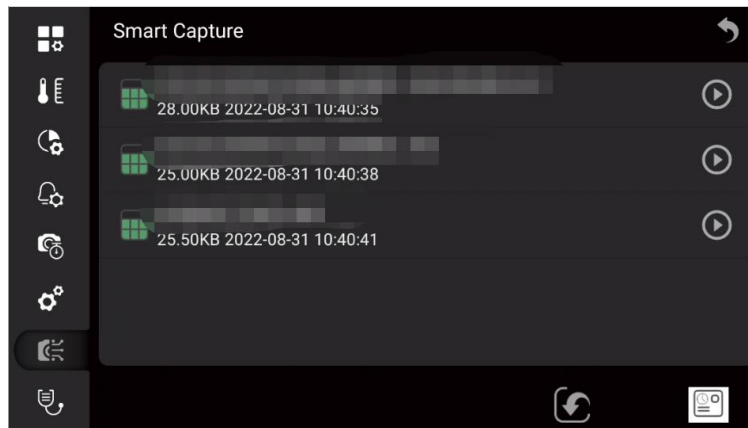



Please follow the below steps.

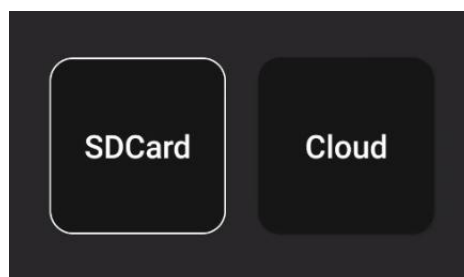

1. Use the joystick to go to  (Import), and press the OK button to pop up a dialog box.

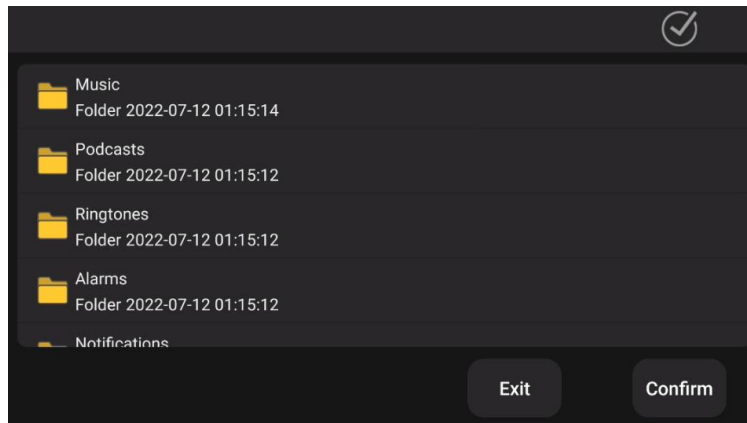

2. Select SD card for importing.



(1) Select the path and file to save the smart capture package, and click  to import.

(2) Click  to select all, and  to exit import.

3. To import from the cloud platform, you need to ensure that you have followed the cloud platform connection operation. For details, see 13 Cloud Platform.

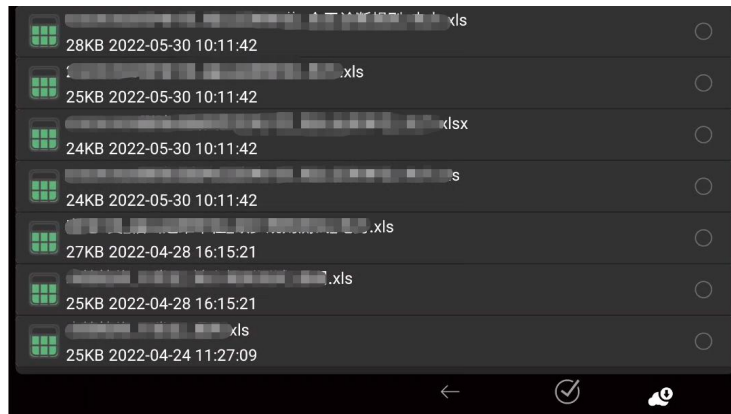

(1) Select the smart capture package to be imported, click  (Download), and then import.

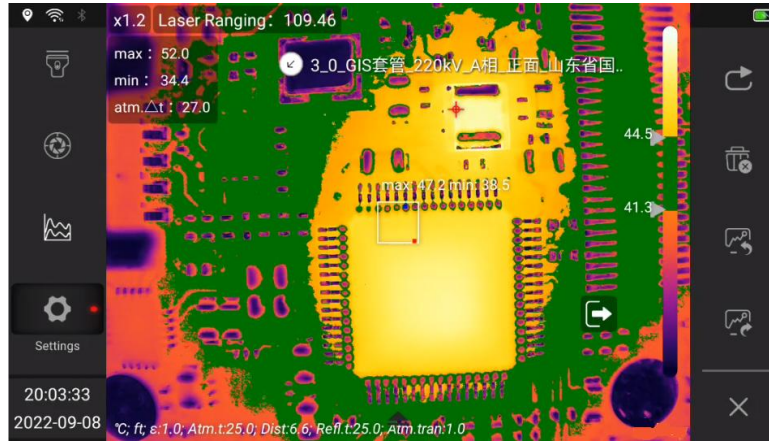

(2) Select  to select all smart capture packages.

4. Use the joystick to go to the smart capture package to be imported, and press the OK button or touch  to load the current smart capture package and return to the real-time preview interface.



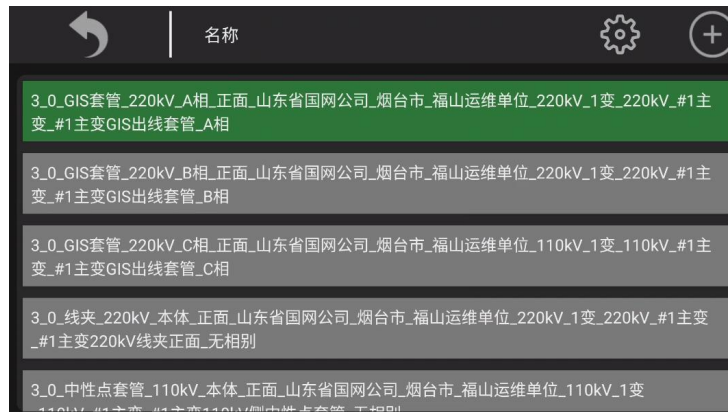



5. Touch the device name to expand the list of subjects.

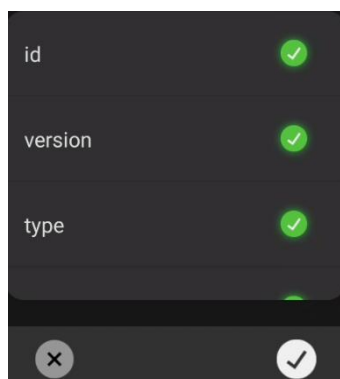

- (1) Move the joystick to switch the subject in the list.
- (2) Go to  (Return) to return to the live shooting screen and continue shooting.
- (3) Go to  (Settings), expand Properties Settings, and select the File Name field as required.



- (4) Go to  (Copy) to copy the currently selected object, whose name ends with \_copy.
- (5) Touch  (Exit) to exit the current Smart Capture mode, or by selecting  (Settings) > Smart Capture >  (Exit).

6. The captured images can be checked in the gallery and sorted in folders named after the properties

of the smart capture package.

7. Image processing, see 8 Saving and processing images.

### 17.8. Smart Diagnostics

Generally, there will be different degrees of aging during the work of power equipment, and heating defects caused by current and voltage will occur. In such situation, periodic inspection is required. The inspection process with a thermal camera requires a lot of practical experience. While, due to experience or operational reasons, defects may be misjudged. In this case, you can use the smart diagnosis of the thermal camera to integrate the power grid diagnosis rules, which can quickly make intelligent defect judgments and reduce tedious on-site analysis and calculation steps, and the diagnosis result can be obtained immediately by shooting.

**Note:** This mode needs to be used with Smart Capture and is not available for some models.

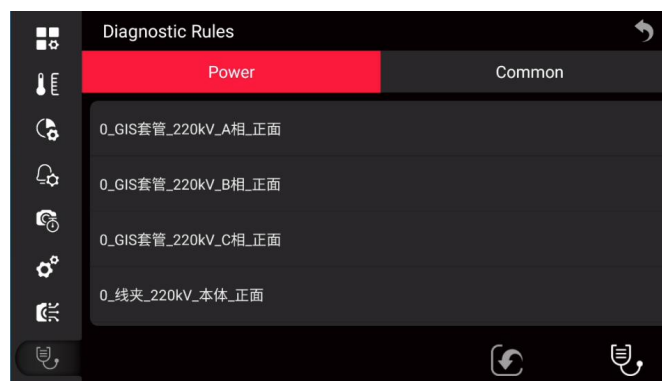



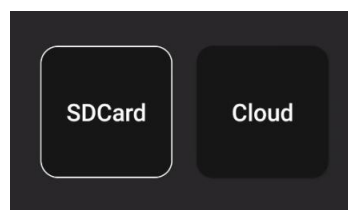

Please follow the below steps.

1. Use the joystick to go to  (Import), and press the OK button to pop up a dialog box.

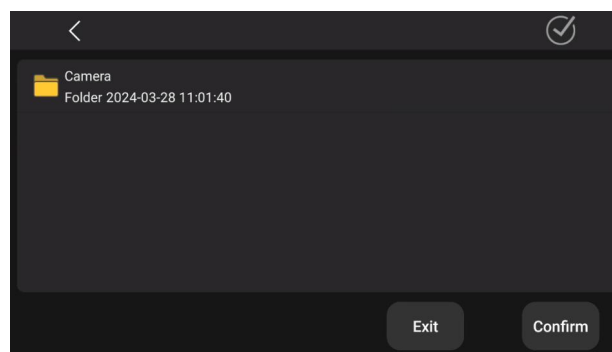

2. Select SD card for importing.



Select the path and file to save the smart capture package, and click  to import. Click  (Select All), and  (Exit Import).

- To import from the cloud platform, you need to ensure that you have followed the cloud platform connection operation. For details, see 13 Cloud Platform.

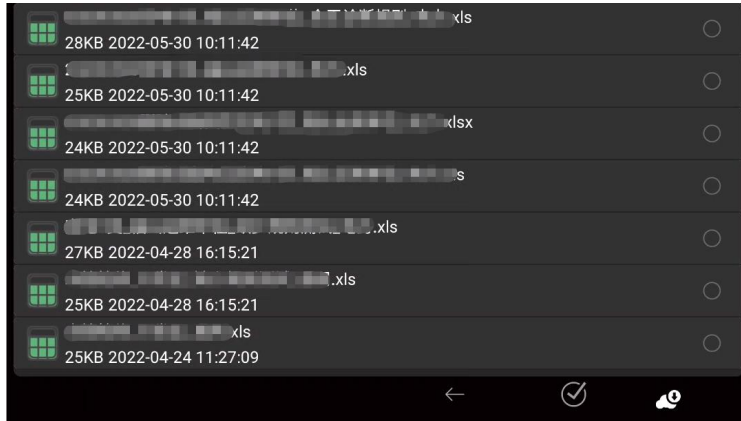

(1) Select the smart capture package to be imported, click  (Download), and then import.

(2) Select  to select all smart capture packages.

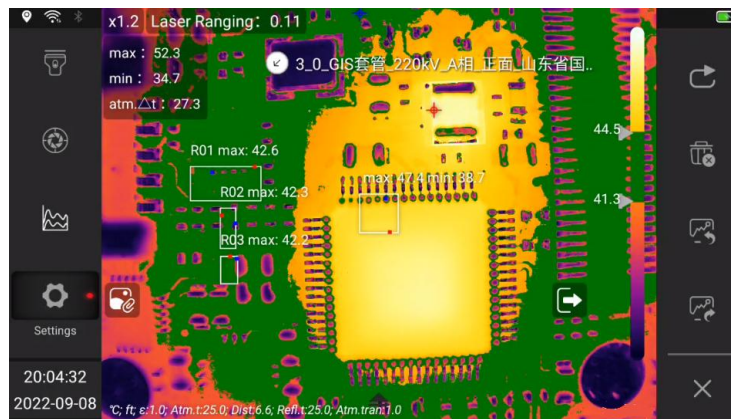

- After importing the smart diagnostic package, it can be used in smart capture mode. For loading the smart capture package, please refer to 17.7 Smart Capture.

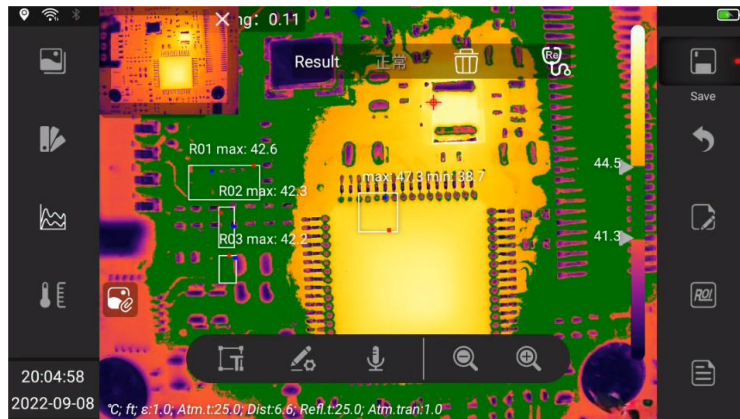

5. Touch  to view the reference graph and analysis tool settings in the current mode, and then touch the screen to return.

6. Press the image capture button to enter the smart diagnosis interface.



7. The diagnosis result is displayed in the diagnosis confirmation column at the top of the screen. Click  (Delete) to clear the diagnosis result, click  (diagnosis) to diagnose again.
8. The captured images can be checked in the gallery and sorted in folders named after the attributes of the smart capture package.
9. Image processing, see 8 Saving and processing images.

## 18. Technical Data

### 18.1. RS1280 25°

<b>Thermal features</b>	Detector Resolution	1280×1024
	Super Resolution	5.1MP
	Lens Configuration	25° lens with auto and manual focus; auto identification after lens change
	FOV	25°×20°
	Focus Mode	Manual, Electric Fine Tuning, One-Click Center Focus, Single-Touch Focus, Smart Focus, Laser-Assisted Focus
	I FOV(Spatial Resolution)	0.34 mrad
	The Min. Imaging Distance	0.5m
	Measurement Range	-20°C~150°C(Low), +150°C~ 800°C(Medium)
<b>Common Features</b>	Detector Type	Uncooled IRFPA Detector
	Thermal Sensitivity	25mK
	Spectral Range	8 - 14 μm
	Image Frequency	30Hz

## RS Series Flagship Thermal Camera·User Manual

	Remote Access & Control	Connect to software on PC or IOS/Android on mobile devices via TYPE-C/Wi-Fi/Hot Spot to control; access to internal data via FTP
	Flashlight	Yes
<b>Image Presentation &amp; Image Mode</b>	Display Size	5.5 in. touch screen, 1920×1080 pixels
	Viewfinder	0.39 in. OLED, 1920×1080 pixels
	Digital Camera	4224×3136 ,13 MP
	Color Palettes	19 types of color palettes such as Iron, Gray, Iron inv., Gray inv.
	Image Mode	Thermal, PIP, Thermal Fusion, Visual, DDE (Unavailable for some models)
	Temperature Scale	Auto, Linear, MAX/MIN, LEVEL/SPAN
<b>Image Storage</b>	Storage Media	SD card, standard 64GB, support hot plug, support SD, SDHC, SDXC, max. extendable to 2TB
	Image Format	jpg
	State Grid Format	Yes
	Storage Qty.	8000
	Text Annotations	Yes, add text annotations via text input, preset texts, OCR, QR code scanning, voice-text conversion
	Voice Annotation	Support, up to 300s voice
	File Naming	Yes, name file via text input, preset texts, OCR, QR code scanning, voice-text conversion
<b>Video Recording &amp; Transmission</b>	Radiometric IR-video Recording	Support compressed radiometric video recording(.irv)
	Non-radiometric IR-Video Recording or Visual Video Recording	Support standard MP4 video recording
	Radiometric IR-video Streaming	View thermal video stream via TYPE-C/Wi-Fi
	Non-radiometric IR-video Streaming	RTSP
	Communication Interfaces	USB3.0, Wi-Fi, MicroHDMI, 4G/5G (Unavailable for some models), MicroHDMI, Bluetooth
	Video Output	HDMI, wireless projection
	Analysis Software	PC and mobile (iOS /Android APP)
	Video Resolution	1920×1080

## RS Series Flagship Thermal Camera·User Manual

<b>Measurement Analysis</b>	Accuracy	±2°C or ±2% of reading at 25°C 5°C~150°C:±1°C or ±1% of reading (the larger value shall prevail) at 25°C; Below 1500°C, ±2°C or ±2% of reading at 25°C
	Measurement Unit	Celsius, Fahrenheit, Kelvin
	Emissivity	0.01-1.00, step 0.01
	Ambient Temperature	-20~50°C, step 0.1°C
	Distance Settings	0~50m, step 0.1m
	Alarm	Audible and image alarms
	Color Alarms(Isotherm)	Above/Below/Interval
	GPS	The location information will be displayed on the image, support GPS, BDS or GLONASS
	Compass	Support DMC indication
	Analysis Report	PDF format, the template can be edited and imported in camera
<b>System Functions</b>	Laser Pointer	Support
	LRF	Support, displayed on screen
	Area Measurement	Support
	Analysis Function in Camera	Movable spot, line, box, polygon (configurable Max./ Min./ Avg./environmental variables/area alarm switch), 30 at most; support at most 5 predefined modes
	Zoom	1-15×, support continuous zoom via adjustment ring
	Data Communication Interfaces	Wi-Fi, Bluetooth, USB Type-C, HDMI
	Voice Control	Voice assistance, fast command recognition
	Smart Patrol	Support, general task package importing and editing, auto image naming
	Smart Diagnosis	No
	Dual-spectrum Video Recording	Yes
	Cloud Platform	Yes (Unavailable for some models)
	Smart Panoramic Stitching	Yes
	Distribution Mode	Yes
Language	English, Polish, Korean, Hungarian, Brazilian Portuguese, German, French, Spanish, Italian, Turkish, Traditional Chinese	



## RS Series Flagship Thermal Camera·User Manual

<b>Others</b>	Microphone/Speaker	Yes
	Battery	4.2V, detachable 9000mAh Li ion battery, support fast charge
	Charging Time	1.5 hours to 90% capacity
	Charging System	In camera or two-bay charger
	Battery Operating Time	Continuous operating time≥ 3 hours (the actual time depends on the environment and use condition)
	Neck Strap	Yes
	Operating Temperature Range	-15°C~ 55°C
	Storage Temperature Range	-40°C~ 70°C
	External Interfaces	TYPE-C USB3.0, SD card, SIM card, Mini HDMI, Tripod Mounting
	Encapsulation	IP54
	Weight and Dimension(L×W×H)	<1.7kg (incl. Battery), 14×21×11.5 cm
	Package Contents	Standard: Thermal camera x1, user manual, calibration certificate, quick start guide, data download card, qualification certificate, multi-country adapter (box), USB data cable x1, lithium batteries x3, portable bag, charging cable x1, HDMI connection cable x1, wrist strap, shoulder strap, SD card, charging dock, standard lens.
	Optional Accessories	Lithium battery, Bluetooth headset, Wide-angle lens, micro-lens, lens bag, portable bag

### 18.2. RS600 25°

<b>Thermal Imaging Features</b>	Detector Resolution	640×512
	Super Resolution	4× Super-Resolution
	Lens Configuration	25° lens with auto and manual focus; auto identification after lens change
	FOV	25°×20°
	Focus Mode	Manual, Electric Fine Tuning, One-Click Center Focus, Single-Touch Focus, Smart Focus, Laser-Assisted Focus
	I FOV(Spatial resolution)	0.68 mrad

## RS Series Flagship Thermal Camera·User Manual

	The Min. Imaging Distance	0.6m
	Measurement Range	-20°C~150°C (Low), +150°C~ 650°C (Medium)
<b>Common Features</b>	Detector Type	Uncooled IRFPA Detector
	NETD	30mk
	Spectral Range	8- 14 μm
	Frame Rate	25Hz
	Remote Access & Control	Connect to software on PC or IOS/Android on mobile devices via TYPE-C/Wi-Fi/Hot Spot to control; access to internal data via FTP
	Flashlight	Yes
<b>Image Presentation &amp; Image Mode</b>	Display Size	5.5-inch touch screen with 1920×1080 resolution
	Viewfinder/EVF	0.39-inch OLED, with 1920×1080 resolution
	Digital Camera	4224×3136 (digital camera with 13MP)
	Color Palettes	19 types of color palettes such as Iron, Gray, Iron inv., Gray inv.
	Image Mode	Thermal, PIP, Thermal Fusion, Visual, DDE (Unavailable for some models)
	Temperature Scale	Auto, Manual, Linear, MAX/MIN, LEVEL/SPAN
<b>Image Storage</b>	Storage Media	SD card, standard 64GB, support hot plug, support SD, SDHC, SDXC, max. extendable to 2TB
	Image Format	jpg
	State Grid Format	Yes
	Storage Qty.	8000
	Text Annotations	Yes, add text annotations via text input, preset texts, OCR, QR code scanning, voice-text conversion
	Voice Annotation	Support, up to 300s voice
	File Naming	Yes, name file via text input, preset texts, OCR, QR code scanning, voice-text conversion
<b>Video Recording &amp; Transmission</b>	Radiometric IR-video Recording	Support compressed radiometric video recording(.irv)
	Non-radiometric IR-Video Recording or Visual Video Recording	Support standard MP4 video recording
	Radiometric IR-video Streaming	Connect to PC software via TYPE-C/WLAN to transmit real-time radiometric infrared video stream.

## RS Series Flagship Thermal Camera·User Manual

	Non-radiometric IR-video Streaming	RTSP
	Communication Interfaces	USB3.0, Wi-Fi, 4G/5G (Unavailable for some models), Micro HDMI, Bluetooth
	Video Output	HDMI, wireless projection
	Analysis Software	PC and mobile (iOS /Android APP)
	Video Resolution	1920×1080
<b>Measurement &amp; Analysis</b>	Accuracy	±2°C or ±2% of reading at 25°C
	Measurement Unit	Celsius, Fahrenheit, Kelvin
	Emissivity	0.01-1.00, step 0.01
	Ambient Temperature	-20~50°C, step 0.1°C
	Distance Settings	0~50m, step 0.1m
	Alarm	Audible and image alarms
	Color Alarms (Isotherm)	Above/Below/Interval
	GPS	The location information will be displayed on the image, support GPS, BDS or GLONASS
	Compass	Support DMC indication
	Analysis Report	PDF format, the template can be edited and imported in camera.
<b>System Functions</b>	Laser Pointer	Yes
	LRF	Yes
	Area Measurement	Support
	Analysis Function in Camera	Movable spot, line, box, polygon (configurable Max./ Min./ Avg./environmental variables/area alarm switch), 25 at most; support at most 5 predefined modes
	Zoom	1-15×, support continuous zoom via adjustment ring
	Data Communication Interfaces	Wi-Fi, Bluetooth, USB Type-C, HDMI
	Voice Control	Voice assistance, fast command recognition
	Smart Patrol	Support, general task package importing and editing, auto image naming
	Smart Diagnosis	No
	Dual-spectrum Video Recording	Yes
	Cloud Platform	Yes (Unavailable for some models)
Smart Panoramic Stitching	Yes	

	Distribution Mode	Yes
	Language	English, Polish, Korean, Hungarian, Brazilian Portuguese, German, French, Spanish, Italian, Turkish, Traditional Chinese
<b>Others</b>	Microphone/Speaker	Yes
	Battery	4.2V, detachable 9000mAh Li-ion battery, support fast charge
	Charging Time	1.5 hours to 90% capacity
	Charging System	In camera or two-bay charger
	Battery Operating Time	Continuous operating time≥ 4 hours (the actual time depends on the environment and use condition)
	Neck Strap	Yes
	Operating Temperature Range	-15°C~ 55°C
	Storage Temperature Range	-40°C~ 70°C
	External Interfaces	TYPE-C USB3.0, SD card, SIM card, Mini HDMI, Tripod Mounting
	Encapsulation	IP54
	Weight and Dimension (L×W×H)	<1.5kg (incl. Battery), 14×21×11.5 cm
	Package Contents	Standard: Thermal camera x1, user manual, calibration certificate, quick start guide, data download card, qualification certificate, multi-country adapter (box), USB data cable x1, lithium batteries x3, portable bag, charging cable x1, HDMI connection cable x1, wrist strap, shoulder strap, SD card, charging dock, standard lens.
Optional Accessories	Lithium battery, Bluetooth headset, Wide-angle lens, micro-lens, lens bag, portable bag	

## **19. Applications Introduction**

### **19.1. Smart Power Inspection and Diagnosis**

With the development of the power system, higher requirements have also been put forward for the safe operation of infrastructure such as power grids and power plant equipment. Major power companies have invested a lot of manpower and material resources in the inspection and maintenance of lines and equipment to ensure the power transmission quality of power enterprises. As an important task to ensure the normal operation of the power system, inspection work can maintain and repair power equipment

efficiently, eliminate hidden problems in the operation of power equipment, and fundamentally improve the safety, efficiency and stability of power equipment.

Integrating flexibility and intelligence, the camera has very high precision and sensitivity, which can measure small temperature differences. So small temperature differences can be found in time during the inspection, reducing the occurrence of abnormal equipment conditions greatly. The functions of intelligent speech recognition and diagnosis make the complex workflow simple, improve the work efficiency, and make it a good helper for expert-level operation and maintenance.

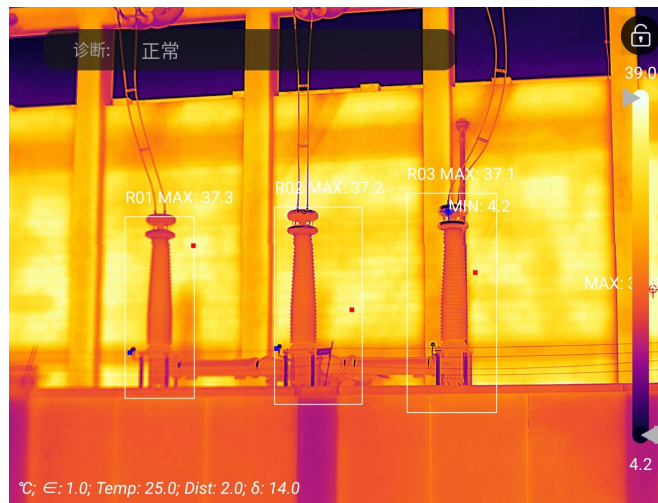

### 19.2. Storage Level Detection

There is a temperature difference between the liquid stored in the storage tank and the upper gas. With the thermal camera, the liquid level of the storage tank can be observed from a long distance, preventing unexpected failures caused by the failure of the liquid level gauge.

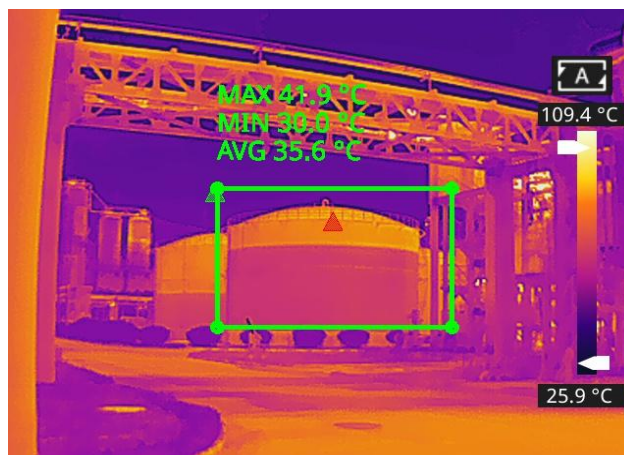

### 19.3. PCB Inspection

PCB is of small size, high integration and complex structure, and it requires a lot of time and efforts with traditional contact detection. Thermal imaging technology has absolute advantages in troubleshooting faulty circuit boards. With the handheld thermal camera, you can quickly find abnormally high or low temperature components and judge circuit board failures.

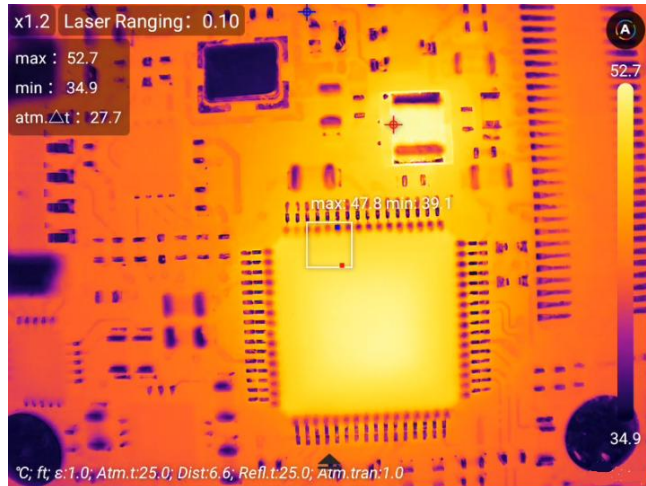

### 19.4. Rotary Kiln Defect Monitoring

Rotary kiln is an important equipment for hazardous waste incineration. The interior of the kiln body is made of refractory materials and the exterior is surrounded by steel plates. With the long-term operation of the rotary kiln, the lining material may get erosive and thin, or even fall off, resulting in abnormally high external temperatures. With the handheld thermal camera, the abnormally high temperature of the outer wall can be found and located, and corresponding measures can be taken to avoid safety accidents.



## 20. Dimensions

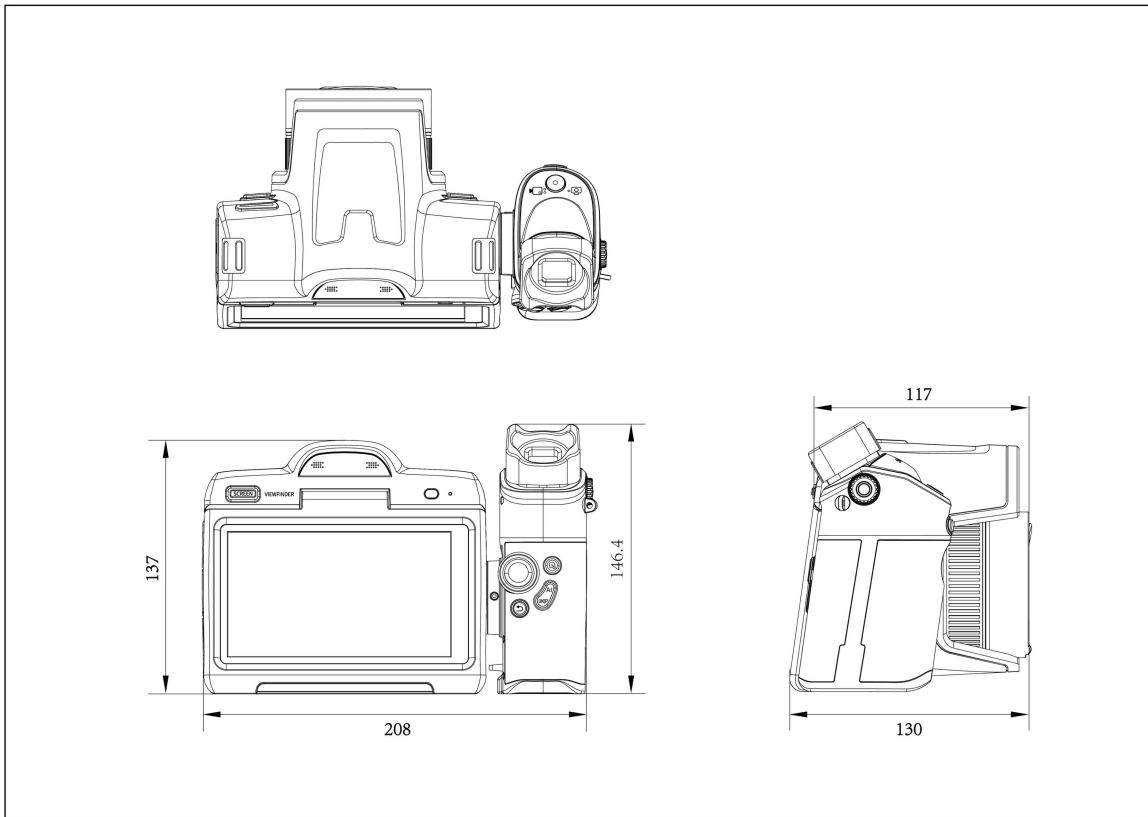

## 21. Cleaning Thermal Camera

### 21.1. Cleaning Camera Housing, Cables and Other Items

Camera Housing, Cables and Other Items	
Liquids	One of the following liquids can be used. 1. Warm water 2. Weak detergent solution
Cleaning Tools	A soft cloth
Cleaning Procedure	Please follow this procedure: 1. Soak a soft cloth in the liquid. 2. Twist the cloth to remove excess liquid. 3. Clean the camera parts with the cloth.



#### CAUTION

Never apply solutions or similar liquids to the camera, cables or other parts directly to avoid damage to the equipment.



## 21.2. Cleaning Infrared Lens

Cleaning Infrared Lens	
Liquids	One of the following liquids can be used. 1. Commercial lens cleaning liquid with more than 30% isopropyl alcohol. 2. 96% ethyl alcohol (C <sub>2</sub> H <sub>5</sub> OH).
Cleaning Tools	Absorbent cotton
Cleaning Procedure	Please follow this procedure (Take dustless cloth as an example). 1. Soak the dustless cloth in the liquid. 2. Squeeze the absorbent cotton to squeeze out the excess cleaning solution. 3. Gently wipe the lens with absorbent cotton, which can be used only once, do not reuse.



### CAUTION

Do not clean the infrared lens too hard. This can damage anti-reflective coating of the lens.

## 21.3. Clean Infrared Detector

Even a small amount of dust on the infrared detector can cause defects to images

**Note:** This section only applies to cameras where removing the lens will expose the IR detector. In some cases, dust cannot be removed by the following procedures, please contact technical support for removal service.



### CAUTION

In step 2 below, do not use compressed air from the pneumatic air circuit in the workshop, which usually contains an oil mist to lubricate the air tools.

**Please follow the below steps to clean detectors.**

1. Remove the lens from the camera.
2. Use compressed air from the compressed air tank to blow off the dust.



## Appendix A Emissivity of Common Materials

### (1) Metal

Materials	Temperature (°C)	Emissivity
<b>Aluminum</b>		
Polished aluminum	100	0.09
Commercial aluminum foil	100	0.09
Light aluminium oxide	25~600	0.10~0.20
Strong aluminium oxide	25~600	0.30~0.40
<b>Brass</b>		
Brass mirror (highly polishing)	28	0.03
Brass oxide	200~600	0.59~0.61
<b>Chromium</b>		
Polished chromium	40~1090	0.08~0.36
<b>Copper</b>		
Copper Mirror	100	0.05
Strong copper oxide	25	0.078
Red copper oxide	800~1100	0.66~0.54
Melting copper	1080~1280	0.16~0.13
<b>Gold</b>		
Gold mirror	230~630	0.02
<b>Iron</b>		
Polished cast iron	200	0.21
Processing cast iron	20	44
Totally rusted surface	20	0.69
Cast iron(oxide at 600°C)	19~600	0.64~0.78
Electrolytic iron oxide	125~520	0.78~0.82
iron oxide	500~1200	0.85~0.89
Iron plate	925~1120	0.87~0.95
Cast iron, heavy iron oxide	25	0.8
Melting Surface	22	0.94
Melting cast iron	1300~1400	0.29

Materials	Temperature (°C)	Emissivity
Melting iron	1515~1680	0.42~0.45
<b>Steel</b>		
<b>Steel(oxidation at 600°C)</b>		
Steel Oxide	100	0.74
Melting low-carbon steel	1600~1800	0.28
Melting Steel	1500~1650	0.42~0.53
<b>Lead</b>		
Pure lead (non-oxide)	125~225	0.06~0.08
Mildly oxidized	25~300	0.20~0.45
<b>Magnesium</b>		
Magnesium oxide	275~825	0.55~0.20
<b>Mercury</b>		
Mercury	0~100	0.09~0.12
<b>Nickel</b>		
Electroplate polished	25	0.05
Electroplate not polished	20	0.01
Nickel wire	185~1010	0.09~0.19
Nickel plate(oxidizing)	198~600	0.37~0.48
Nickel oxide	650~1255	0.59~0.86
<b>Nickel alloy</b>		
Nichrome wire(heatproof)(bright)	50~1000	0.65~0.79
Nichrome	50~1040	0.64~0.76
Nickel-chromium(heatproof)	50~500	0.95~0.98
<b>Silver</b>		
Polished silver	100	0.05
<b>Stainless steel</b>		
18/8stainless steel	25	0.16
304(8Cr,18Ni)	215~490	0.44~0.36
310(25Cr,20Ni)	215~520	0.90~0.97
<b>Tin</b>		
Commercial tin plate	100	0.07

Materials	Temperature (°C)	Emissivity
<b>Zinc</b>		
Oxidized at 400°C	400	0.01
Galvanized bright iron plate	28	0.23
Gray zinc oxide	25	0.28

**(2) Nonmetal**

Material	Temperature (°C)	Emissivity
Brick	1100	0.75
Firebrick	1100	0.75
graphite(lamp black)	96~225	0.95
enamel(white)	18	0.9
Pitch	0~200	0.85
Glass(surface)	23	0.94
Heatproof glass	200~540	0.85~0.95
Calcimine	20	0.9
Oak	20	0.9
Carbon plate	-	0.85
Insulating strip	-	0.91~0.94
Sheetmetal	-	0.88~0.90
Glass tube	-	0.9
Coil form	-	0.87
Enamelware	-	0.9
Enamel pattern	-	0.83~0.95
<b>Capacitor</b>		
Rotation type	-	0.30~0.34
Ceramics(bottle type)	-	0.9
Film	-	0.90~0.93
Mica	-	0.94~0.95
Liquid mica	-	0.90~0.93
Glass	-	0.91~0.92
<b>Semi-conductor</b>		

Material	Temperature (℃)	Emissivity
Crystal valve(plastic package)	-	0.80~0.90
Crystal valve(metal)	-	0.30~0.40
Diode	-	0.89~0.90
<b>Transmission coil</b>		
Pulse transmission	-	0.91~0.92
Flat chalk	-	0.88~0.93
Top ring	-	0.91~0.92
<b>Electronic material</b>		
Epoxy glass plate	-	0.86
Epoxy phenolic plate	-	0.8
Gold-plated copper	-	0.3
Coating copper	-	0.35
Tin-plated lead wire	-	0.28
Copper wire	-	0.87~0.88

## — Raythink, sense difference —